

GUIDELINES

CONSTRUCTION WITH CROSS-LAMINATED TIMBER IN MULTI-STOREY BUILDINGS

Focus on Building Physics



Presented by



PUBLISHED BY
HOLZFORSCHUNG AUSTRIA
A-1030 Wien, Franz Grill-Straße 7
Tel. +43 1 798 26 23 - 0 (Fax DW - 50)
hfa@holzforschung.at
www.holzforschung.at

ISBN 978-3-9519933-2-4
Issue 72 of HFA Schriftenreihe
Translation of the 3rd german edition, May 2021

Holzforschung Austria is a member of



**Construction with Cross-Laminated Timber in
Multi-Storey Buildings
Focus on Building Physics**

Guidelines

Authors

Dr. Martin Teibinger

Dipl-HTL-Ingⁱⁿ Irmgard Matzinger

Dr. Franz Dolezal

Project team member

Ing. Markus Novacek

Translation

Boris Sandor, MSc.

Companies involved

Hasslacher Holding

Knauf Gesellschaft m.b.H.

Mayr-Melnhof Holz Holding AG

Stora Enso Wood Products GmbH

Vienna, May 2021

Foreword to the third edition (2018)

The multi-storey timber construction has developed rapidly since the first edition of this technical brochure was published (2013). In the meantime, it has grown beyond building class 4 and has already reached building class 5 with six above-ground floors - without a fire protection concept.

For example, the currently tallest wooden building in the world, the “HoHo” in the urban development area “Seestadt Aspern” in Vienna, has already reached a height of 84 meters. At the international level there are increasingly such lighthouse projects which are also being implemented.

Further projects were developed in the research area, the state of the art has changed. The standardization and the OIB guideline from Austrian Institute of Construction Engineering have been revised, which has also made it necessary to update this brochure. We have therefore decided to revise the now third edition on these points.

It should continue to serve as an up-to-date reference work for planners, architects and contractors, but the brochure cannot replace reliable building physics planning and advice.

We would like to take this opportunity to thank all of the colleagues at Holzforschung Austria who were involved in the revision for their technical expertise and persistent support.

Bernd Nusser, Irmgard Matzinger

Foreword to the first (2013) and second (2014) edition

Amendments to building regulations during the nineties of the 20th century initiated a revival of multi-storey timber buildings in Austria. In cooperation with the Technical Universities of Vienna and Graz as well as renowned testing institutions, Holzforschung Austria elaborated guidelines for multi-storey timber buildings in framework, skeleton and solid construction. These were published by proHolz Austria.

Due to current developments in research, increased requirements and occasional uncertainties among planners and producers, it turned out to be necessary to elaborate a guideline based on building physics for multi-storey solid-timber construction.

The present brochure summarizes the results of research projects and practical building experiences from the use of cross-laminated timber up to building class 4 from the view of building physics. Apart from other experts, those of Holzforschung Austria were involved in the research projects mentioned. Representative for all colleagues, special thanks go to Peter Schober and Franz Dolezal for constructive consultations and corrections.

Besides general principles for constructing with timber or cross-laminated timber, the current guideline details current building-physical requirements and solutions concerning all the details and superstructures in examples. Recommendations for building practice and corrections of faults in execution round off the brochure. The detailed representations given are exemplary solutions; if appropriately verified, alternatives are possible. The current brochure supports the implementation of multi-storey timber constructions, however, it cannot replace planning based on building physics and legal advice. As deviations are sure to arise in concrete construction projects, Holzforschung Austria cannot take liability of any type.

This brochure has been prepared as part of contract research of the companies Hasslacher Norica Timber, Knauf Gesellschaft m.b.H., Mayr-Melnhof Holz Holding AG und Stora Enso Wood Products GmbH.

This is the place to thank all of them for good and constructive cooperation as well as financial and material support.

Martin Teibinger

TABLE OF CONTENTS

1	Introduction.....	1
1.1	General advantages of timber constructions.....	1
1.2	Timber constructions.....	2
1.3	Solid timber constructions.....	3
1.3.1	Fundamental properties of cross-laminated timber.....	3
1.3.2	Constructional principles for cross-laminated timber.....	3
1.3.3	Building physics properties of cross-laminated timber.....	4
1.4	Combinations of timber constructions.....	5
2	Prefabrication.....	7
3	Fire protection basics.....	9
3.1	General.....	9
3.2	Fire Phases.....	10
3.3	Reaction-to-fire performance of construction materials.....	11
3.4	Fire resistance.....	13
3.4.1	General.....	13
3.4.2	Charring rate β_0 for cross-laminated timber.....	14
3.4.3	Structural design of load-bearing capacity R of cross-laminated timber elements.....	17
3.4.4	Design of the integrity EI of cross-laminated timber elements.....	17
3.5	Facades.....	19
3.6	Legal Requirements.....	20

3.6.1	General	20
3.6.2	Fire compartments	21
3.6.3	Facades	23
3.6.4	Penetrations	25
3.7	Deviations	25
4	Sound protection basics	27
4.1	General	27
4.1.1	Calculation basics in acoustics	28
4.1.2	Assessment in building acoustics	29
4.2	Protection against airborne noise	30
4.2.1	Airborne sound insulation of single-leaf solid components	32
4.2.2	Airborne sound insulation of additional-leaf light components (timber frame construction)	33
4.2.3	Airborne sound insulation of single-leaf, solid, but light components (solid timber constructions)	34
4.3	Structure-borne sound	35
4.3.1	General	35
4.3.2	Reduction of structure-borne sound	36
4.4	Flanking transmission	39
4.5	Requirements	40
4.5.1	Requirements for external components	40
4.5.2	Requirements for internal components	41
5	Heat protection basics	43
5.1	General	43

5.2	Heat conductivity	43
5.3	U value	45
5.4	Summer suitability	46
5.5	Requirements	48
6	Moisture-protection basics	49
6.1	General.....	49
6.1.1	Water vapor saturation pressure.....	49
6.1.2	Water vapor partial pressure.....	49
6.1.3	Relative air humidity	50
6.1.4	Absolute humidity	50
6.2	Diffusion	51
6.2.1	Water vapor diffusion resistance.....	51
6.2.2	Water vapor diffusion equivalent air layer thickness.....	51
6.3	Convection	52
6.4	Requirements	53
7	Common superstructures in cross-laminated timber constructions	55
7.1	External wall	55
7.1.1	Examples.....	57
7.1.2	Constructive rules.....	59
7.2	Load-bearing internal wall.....	61
7.3	Partition wall	62
7.3.1	Examples.....	63

7.3.2	Constructive rules	65
7.4	Fire compartment forming wall	67
7.4.1	Example	67
7.4.2	Construction rules	68
7.5	Elevator walls	68
7.6	Separating floor	69
7.6.1	Example	70
7.6.2	Constructive rules	70
7.6.3	Constructive recommendation	74
7.7	Flat roof	76
7.7.1	Examples	77
7.7.2	Construction rules	77
7.7.3	Constructive recommendations	78
8	Connection details	81
8.1	Base part	81
8.1.1	General	81
8.1.2	Constructive Rules	83
8.2	Window insertion	84
8.2.1	General	84
8.2.2	Constructive Rules	84
8.3	External wall corner	87
8.4	Element butt joint	88
8.5	Gypsum board connections	90
8.6	Separating floor support	92

8.6.1	General.....	92
8.6.2	Constructive Rules.....	95
8.7	Connection details for components forming fire compartments.....	98
8.7.1	Technical execution.....	98
8.7.2	Connection of the fire compartment forming partition wall to the external wall.....	98
8.7.3	Connection of the fire compartment forming separating floor to the external wall.....	100
8.7.4	Connection of the fire compartment forming partition wall to the floor.....	103
8.7.5	Connection of the fire compartment forming partition wall to the roof.....	104
8.8	Penetrations.....	106
8.8.1	Vertical distribution.....	106
8.8.2	Constructive Rules.....	110
8.8.3	Horizontal distribution.....	112
8.8.4	Partitioning systems through fire compartments.....	112
8.9	Wood Facades.....	124
8.9.1	Heat and Moisture Protection.....	124
8.9.2	Fire Protection.....	125
8.10	Detailed solutions for plastered facades.....	130
8.11	Balconies and Loggias.....	131
9	List of Figures.....	134
10	List of Tables.....	139
11	Table of References.....	141

12 List of Standards..... 145

1 Introduction

1.1 General advantages of timber constructions

The increased use of wood in building construction has gained high significance both with a view to ecology and economics, besides the building physics benefits of comfortability and indoor climate. The use of wood as a building material creates a carbon dioxide sink.

Trees convert 0.9 tons of carbon dioxide (CO₂) which is absorbed from air with 0.5 tons of water and by means of 9,500 MJ of sun energy into 1 cubic meter of biomass (wood) in the course of photosynthesis. Carbon accounts for one half of one cubic meter of wood. These figures underline the significance of woods as carbon sinks. In Austrian woods, there is roughly 1 billion cubic meters of wood where the amount of wood required for one detached house accrues every 40 seconds [Jörg 2010].

If the wood taken from trees is used over longer terms, a corresponding amount of carbon can be stored during its operating life. Additionally, more energy is stored than is required for production. According to cascading use based on [Jörg 2010], more than a half of the solar energy of wood stored can be used as energy of heat or electric power. While about 0.7 metric tons of carbon is stored in the furniture of a three-room apartment, about 16 metric tons are contained in a modern single-family house with timber construction [Frühwald et al. 2001].

1.2 Timber constructions

Basically, timber constructions can be divided into skeleton, framework and solid timber constructions, see Figure 1. In Central Europe, panel construction using prefabricated elements is predominantly used for the construction of single-family houses. Solid timber construction with prefabricated panels, especially with cross-laminated timber, is well established in the construction of multi-storey timber buildings, whereas skeleton constructions have a minor role. Mixed forms of constructions were often used. In cross-wall construction, the benefits of cross-laminated timber relating to load transfer for load-bearing components and those of heat-protection of framework construction for external components are often ideally combined.

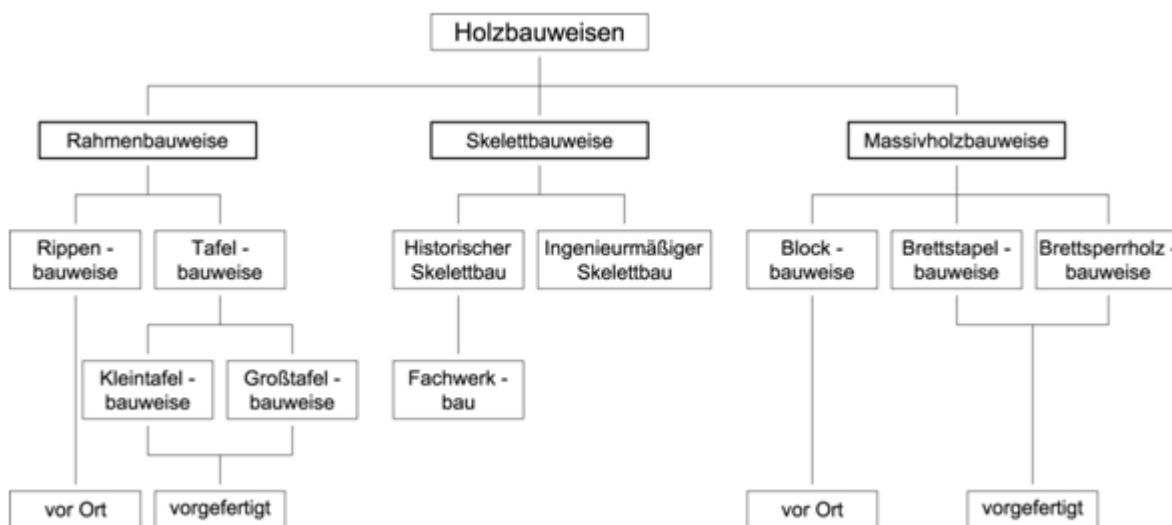

Figure 1: Classification of timber constructions in residential construction

Timber frame construction is characterized by a modular grid of construction timber elements (usually 62.5cm) which is bilaterally clad with wood- or plaster-based structural wood panels. The paneling is used also for horizontal stiffening. Insulating materials are inserted into the plane of construction timber. A vapor retarder (OSB or film) is positioned, which is usually also the air-tight plane, on the inside.

In contrast, there is a clear separation of supporting structure and insulation plane in case of cross-laminated timber construction. The two-dimensional solid wood element serves to transfer load and for stiffening, contributes to the fire resistance of the entire component and can also be regarded as "heat insulation" due to the low heat conductivity of wood compared to other load-bearing materials. For cross-laminated timber constructions, vapor barriers or flow-tight sheets are provided on the wood element outside, if any.

1.3 Solid timber constructions

1.3.1 Fundamental properties of cross-laminated timber

Cross-laminated timber elements are used as load-bearing components. These are elements that are made of boards sorted according to strength, having widths ranging between 80 and 240 mm. Board thicknesses are between 19 and 45 mm. The wood species used are mainly common spruce or fir, but also pine and larch.

Typically, individual plies - usually 3, 5 or 7 plies - are extensively glued together while alternatively turning them by 90°, using adhesives that are admitted for load-bearing purposes. This causes load-bearing performance as well as swelling and shrinking behavior to be homogenized. Depending on the number of plies and individual thicknesses of plies, element thicknesses can be between 57mm and 400mm. Typically, 3- or 5-ply elements having thicknesses between 80 and 120mm are used for wall components and 5- or 7-ply elements having thicknesses between 140 and 200mm are used for floors.

Element dimensions depend on production conditions of the respective producers and of transportation means. Suppliers of large-format panels basically offer standard widths between 2.40m and 3m and lengths of 12m to 20m.

Due to possible combinations of length and width of cross-laminated timber elements, there is a variety of most diverse structures that can be used for optimizing with regard to statics, construction and fire protection. During recent years, there has been a trend towards integer nominal thicknesses in the centimeter range as a contribution to standardizing this type of construction.

Possible uses, manufacture and mechanical properties of cross-laminated timber elements of various manufacturers are regulated in the respective Technical Approval.

1.3.2 Constructional principles for cross-laminated timber

Cross-laminated timber construction offers constructive advantages as follows:

- Bracing of the building and, at the same time, transfer of vertical loads
- Simple possibility for connections
- No need to stick to a grid
- Construction allows two-dimensional spatial "thinking"
- Horizontal forces (e.g. wind and seismic loads) shall be transferred through covering areas into vertical shear walls and then into the foundations
- Additional reserves through edge clamping of floor elements (biaxial state of floors)

The following basic construction principles shall be considered in the planning of cross-laminated timber constructions for optimizing cost of buildings:

- Arrangement of load-bearing wall slabs lying on top of each other

- Keep span widths in an economic range

Table 1: Recommended values of free span widths for timber floors

Construction	economic span width [m]
Timber frame floor	up to 4
Cross-laminated timber floor	up to 5
Cross-laminated timber floor as a continuous beam	up to 6
Ripped slab (floor beams) Cross-laminated timber element with glued-on ribs	up to 10
Timber-concrete composite floor	up to 10

- Arrangement of window openings on top of each other
- Continuous parapets (walls used as beams)
- Always put balconies in front for reasons of building physics

Additional construction rules and dimensioning of cross-laminated timber elements are exemplified in [Wallner-Novak et al. 2012].

1.3.3 Building physics properties of cross-laminated timber

Planners appreciate cross-laminated timber because of the possibility of producing simple wall, floor and roof constructions, besides its static advantages. There are the following physical advantages:

- Simple layer structures, clear separation between load-bearing structure and insulation plane
- Simple joining technology
- Void-free constructions are possible
- Good air-tightness without any additional flow-tight sheets can be achieved (nearly zero energy buildings or passive houses need to be separately discussed)

- Generally, no vapor retarder is required (it is needed, e.g. for flat roof constructions, apply outside the timber construction)
- Decorative wood finish, thus untreated wood surfaces can be used on the inside for improving indoor climate (preferably for floor constructions)
- Higher storage-effective mass in case of direct cladding or decorative wood finish

1.4 Combinations of timber constructions

In the past, it turned out that a combination of cross-laminated timber and timber frame constructions used in multi-storey objects can be regarded as positive in terms of building construction as well as economics and ecology. Load-bearing wall bulkheads (internal walls and partition walls) as well as floor elements are implemented as cross-laminated timber constructions, while the timber frame constructions are used for non-load bearing walls. This allows to combine heat-protection advantages - more slender external wall of frame constructions - with the static advantages of cross-laminated timber constructions in a sustainable way. Thus, even medium-sized timber construction companies can implement multi-storey objects if their production plants are used to capacity.



Figure 2: Combination of cross-laminated timber floor and non-load bearing external wall in timber frame constructions

2 Prefabrication

Prefabricated construction is simple construction for the client. The entire planning of the building, the project management and the coordination of the trades are in one hand. A high degree of prefabrication offers structural and economic advantages due to the weather-independent production and the short assembly times. Depending on the general conditions, 100 - 150 m² net usable area can be built per day. Prefabrication does not exclude individual building, almost any architectural specification can be implemented. The advantage of the planners is that, depending on the requirements, they can fall back on tried and tested wall structures made of different materials. These systems can be used as required (energy indicators, building physics requirements, appearance, etc.). The shorter assembly times also reduce the cost of setting up the construction site. The degree of prefabrication with built-in windows and finished facade means that it can be installed regardless of the weather. On large construction sites, it is recommended to apply scarfing cardboard or a robust film to the raw ceiling elements as protection from the weather. A high level of prefabrication offers additional advantages in terms of quality assurance.

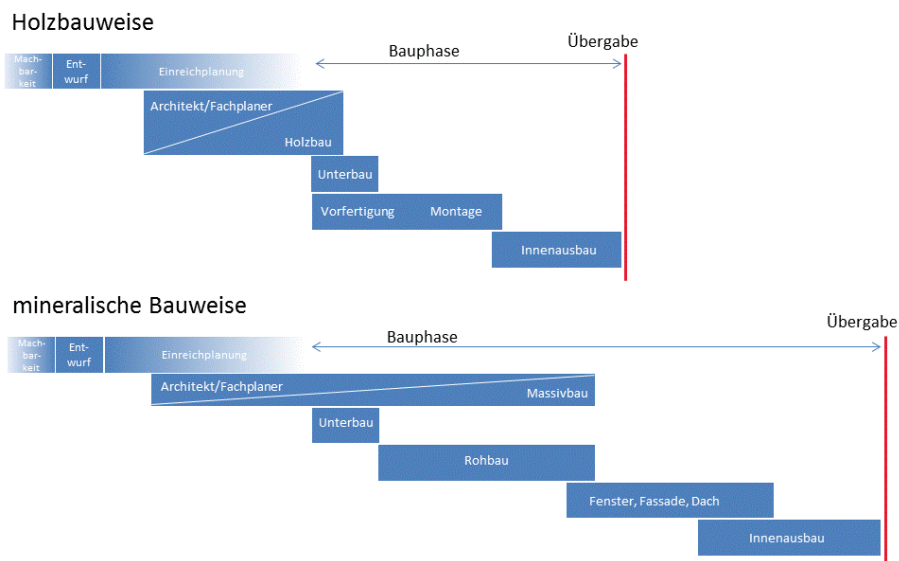

Figure 3: Overview comparison of the planning and construction processes of timber construction and mineral construction

However, prefabrication also requires a change in the planning process. All details must be agreed in advance with all specialist planners; subsequent changes or on-site decisions make the construction costs more expensive.

3 Fire protection basics

3.1 General

Fire protection:

- Fire deaths are usually due to smoke. Fire detectors (according to OIB guideline 2 required in all common rooms except kitchens) protect human lives.
- There is a risk of toxicity from the combustion products from furnishings (mobile fire load), particularly from mattresses, sofas, curtains, etc. 1 kg of foam rubber smokes a 100 m² apartment in approx. 6 minutes. (Czech, K.J. et al, 1999).
- There is no connection between the construction method and the number of fire deaths. (Gieselbrecht, K. 2012)
- A non-combustible construction method not more secure in terms of fire protection.
- A variety of tested timber construction solutions is available (e.g. www.dataholz.com).
- Defective connections and penetrations represent a risk, regardless of the construction method.

The guarantee of fire protection when using combustible construction methods is still seen by parts of the population as impossible or difficult to implement. The developmentally shaped fear of fire or the collective memory of historical fire disasters is too great. Large-scale fire disasters were a danger for centuries, especially in cities. When these catastrophes are discussed today, the scarce development within the fortifications, the careless use of open fire, the lack of or simple fire-fighting measures and the combustible roof coverings, which were the main reasons for the fire's origins and rapid spread, are barely taken into account. On the part of the rulers, guidelines were drawn up step by step with regard to preventive fire protection in order to eliminate the causes of the fire. The first legal requirements in Vienna go back to the beginning of the 14th century with the requirement of a non-combustible chimney. From 1432, the twice yearly official inspection by chimney sweeps was requested. For a long time, the need for requirements with regard to combative fire protection was not recognized. In Vienna, for example, the foundation stone for the professional fire brigade was not laid until the second half of the 17th century with the 4 "fire servants" and the centralization of the extinguishing devices. Today, structural, organizational and system-related fire protection measures ensure that buildings are safe in terms of fire protection.

3.2 Fire Phases

A fire can basically be divided into two phases, see Figure 4. In the first phase of fire initiation, there is a slow, low temperature rise. This phase can be further divided into ignition phase and smoldering phase. During this phase, the reaction-to-fire performance of the cladding and coverings used (building material behavior) is critical as it can contribute to fire spreading. At the time of so-called flash over, there is a rapid temperature rise. All of the combustible materials and gases in the area of fire ignite in sudden bursts. A flash-over can be expected to occur seven to fifteen minutes after fire initiation, depending on fire loads and ventilation conditions. During fire experiments in nature, flash-overs were created even after 30 seconds under "optimum" conditions. From this point of time, this is called a mature fire, which may be divided into heating and cooling down phases. During this phase, the term component behavior is used. There are requirements imposed on the fire resistance of components.

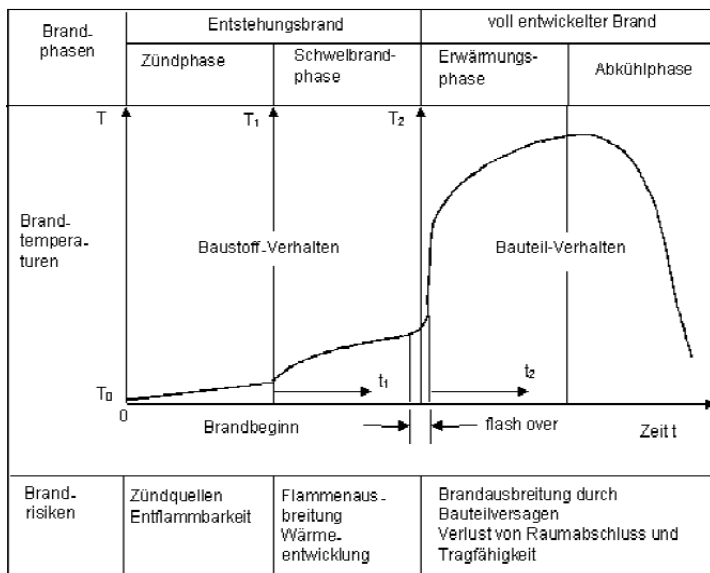

Figure 4: Fire phases, source: [Schneider 2009]

Mixing the requirements, for example R 30 or A2, means that a combustible component must have a fire resistance of 30 minutes, while a non-combustible component has no fire resistance requirements. Due to the different protection goals corresponding to the fire phases shown in Figure 4, this requirement is not expedient.

3.3 Reaction-to-fire performance of construction materials

Essential properties for evaluating construction materials regarding reaction-to-fire performance are ignitability, flammability, flame propagation, fume development and combustion rate. As these properties depend on countless factors, standardized tests are carried out to ensure comparability in terms of reaction-to-fire performance of individual materials. In the past, construction materials were divided in Austria with regard to flammability according to [ÖNORM B 3800-1] into two fire classes A [incombustible] and B [combustible], which can be sub-divided as follows:

Table 2: Classification of Flammability according to ÖNORM B 3800-1 (redacted on 01.07.2004)

Flammability		Smoke formation		Dripping behavior	
A	Nonflammable	Q 1	Weakly smoking	Tr 1	Non dripping
B1	Hardly flammable	Q 2	Normally smoking	Tr 2	Dripping
B2	Normally flammable	Q 3	Heavily smoking	Tr 3	Ignitingly dripping
B3	Highly flammable				

This standard has been withdrawn and replaced with [ÖNORM EN 13501-1]; there are still references made to fire classes according to [ÖNORM B 3800-1] in various federal laws.

Construction materials, except for floor coverings, are divided according to [ÖNORM EN 13501-1] as follows:

Table 3: Classification of fire protection classes according to ÖNORM EN 13501-1

Reaction-to-fire performance		Smoke development		Drip and/or drop off	
A 1, A 2	Nonflammable	s 1	Least contribution	d 1	No burning drip/drop off
B, C, D, E, F	flammable	s 2		d 2	No continuous burning drip/drop off
		s 3		d 3	

An assignment of previous Austrian classes to European classes and vice versa is inadmissible due to different test methods. In order to reduce the expenditure of testing and classification required for this, the European Commission made it possible to classify materials with known reaction-to-fire performance and defined properties of materials without additional tests (classification without further testing cwft). In compliance with the decision of the European Commission 2003/43/EC, cross-laminated timber components to be used for wall, floor, roof or special components shall be assigned to Euro class D-s2-d0 according to [ÖNORM EN 13501-1]. A complete list of fire protection classes can be downloaded from www.eur-lex.europa.eu. Table 4 exemplifies the reaction-to-fire performance of selected construction materials.

Table 4: Reaction-to-fire performance of selected construction materials

Material	Product standard	Reaction-to-fire performance
Expanded polystyrene foam (EPS)	ÖNORM EN 13163	E-s2, d0
Gypsum plasterboard	ÖNORM EN 520	A2-s1, d0
Gypsum fiberboard	ÖNORM EN 15283-2	A2-s1, d0
Magnesite-bonded wood wool Insulation board	ÖNORM EN 13168	B-s1, d0
Structural timber	Decision of the Commission 2003/593/EG dated August 07, 2003	D-s2, d0
Glued laminated timber	Decision of the Commission dated August 09, 2005	D-s2, d0
Cross-laminated timber	ÖNORM EN 16351	D-s2, d0
MDF	ÖNORM EN 622-5	D-s2, d0
OSB	ÖNORM EN 300	D-s2, d0
Fiberboard	ÖNORM EN 312	D-s2, d0
Cement-bonded fiberboard	ÖNORM EN 634-2	B-s1, d0
Mineral wool	ÖNORM EN 13162	A1/A2*-s1, d0

* depending on mineral wool binder

Flammable construction materials are tested for classification of their reaction-to-fire performance according to the so-called SBI test [ÖNORM EN 13823]. For the test, a paper basket or the like positioned in a corner of the room is regarded as a fire scenario. In the test, products are tested in a corner position under final fitting conditions ("end use conditions") with a triangular line burner. For classification, the most intense rise in heat release rate during the test (FIGRA index measured in W/s), the entire amount of heat released during the test (THR_{600s} in MJ), the maximum rate of smoke development (SMOGR index in m^2/s^2), the entire amount of smoke released (TSP_{600s} in m^2) as well as the fall of burning parts and drops are used for this purpose. Furthermore, classification requires investigations into the flammability of construction materials [EN ISO 11925-2], to determine the heat of combustion or test their incombustibility [ÖNORM EN 1182].

3.4 Fire resistance

3.4.1 General

Contrary to previous fire resistance classes (F classes), for the fire resistance classes REI, a distinction can be made between load-bearing components and/or components that form fire compartments.

Table 5: Designations for fire resistance according to ÖNORM EN 13501-2 (abstract), figures taken from [Östman et al 2010]



Letter symbol	Requirement	Figure
R	Load-bearing capacity	
E	Integrity	
I	Heat insulation	

Table 6: Examples of designations for fire resistance

Designation	Requirement	Component example
R 30, R 60, R 90	Load-bearing component	Support, wall, beam
EI 30, EI 60, EI 90	Space-enclosing, heat insulating component	Non-load bearing separating components, shaft walls, partitions
REI 30, REI 60, REI 90	Load-bearing and space-enclosing heat-insulating component	Load-bearing separating component

For verification, classification reports according to [ÖNORM EN 13501-2] may be used on the basis of fire resistance tests according to the ÖNORM series EN 1364 or EN 1365.

For wooden components, it is also possible to do calculations according to [ÖNORM EN 1995-1-2] combined with the respective national application documents. Calculation examples of solid wood components can be taken from [Östman et al 2010].

3.4.2 Charring rate β_0 for cross-laminated timber

3.4.2.1 Rated value of charring rate β_0 for cross-laminated timber with unprotected surfaces

The rated value of charring rate of coniferous wood is 0.65 mm/min according to [ÖNORM EN 1995-1-2]. This value may be used for the top layer. Due to temperature influences, a softening of the glue line may occur if polyurethane adhesives are used, which may result in the carbon layer coming off in small structures. Later, until a carbon layer of about 25 mm is formed from the nearest layer exposed to fire, the combustion rate is doubled [Frangi et al. 2008; Östman et al 2010]. Based on experimental investigations, these combustion rates were confirmed [Teibinger und Matzinger 2010].

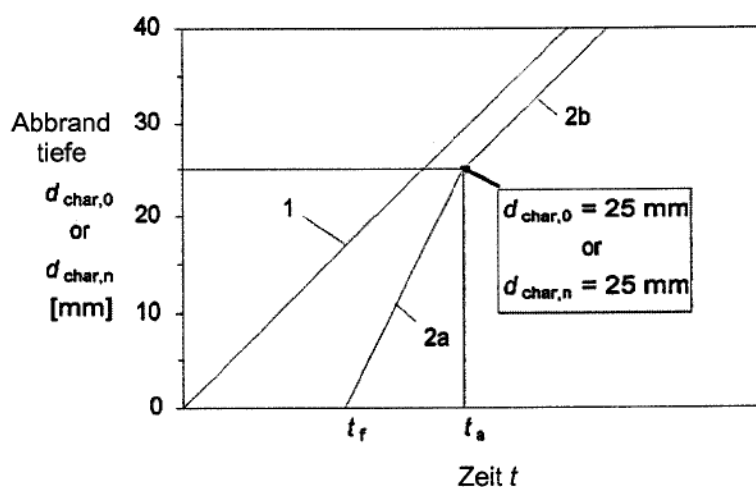

Figure 5: Representation of increased charring depth of another layer if the carbon layer of the top (2a) falls off, reduced combustion if a carbon layer of 25mm is formed (2b) and of constant burn-off without flaking off of the carbon layer (1), source: [ÖNORM EN 1995-1-2]

The rated values of combustion rate shown in Table 7 were determined through loaded large scale fire tests [Teibinger und Matzinger 2010] and have to be used in calculations. If deviating rated values are available that have been determined through large scale fire tests, those may be used for calculations. Mass burning rates determined from small scale fire tests cannot be compared with values determined from large scale fire tests.

Table 7: Rated values of mass burning rates β_0 for cross-laminated timber elements depending on bonding of individual plies

Ply	Component	carbon layer of top ply come off	β_0 [mm/min]
Top ply	Wall Floor or roof	---	0.65
Further plies	Floor or roof	yes	1.3
Further plies	Floor or roof	no	0.8
Further plies	Wall	yes	0.9
Further plies	Wall	no	0.7

3.4.2.2 Rated value of charring rate β_0 for cross-laminated timber with initially protected surfaces

With surfaces of cross-laminated timber elements initially protected from fire, the starting point of combustion behind planking t_{ch} and failure time of planking t_f are crucial.

With wooden composite boards and gypsum boards types A and H according to [ÖNORM EN 520] or GKB according to [ÖNORM B 3410], failure time t_f is equated with the start of combustion of the wooden construction t_{ch} . The standard states formulae for calculating t_{ch} for individual fire protection claddings. After the start of combustion and falling off of planking, which is equated with the former, an increased rate of combustion (according to the standard twice as high) occurs on the basis of a charcoal layer that has not formed yet until the point of time t_a . After a burn-up depth of 25mm, the usual rate of combustion comes back again. This corresponds to the course of combustion with delamination occurrences of the top ply, see Figure 5.

With gypsum plasterboards type F according to [ÖNORM EN 520] or GKF according to [ÖNORM B 3410], the combustion rate is reduced from start of combustion until the fire protection cladding fails; subsequently, a doubled and then constant rate of combustion occurs until a 25mm thick carbon layer has formed, see Figure 6. The start of combustion is calculated according to [ÖNORM EN 1995-1-2] where the thickness of the external cladding and 80% of the internal cladding thickness are used for multilayer cladding.

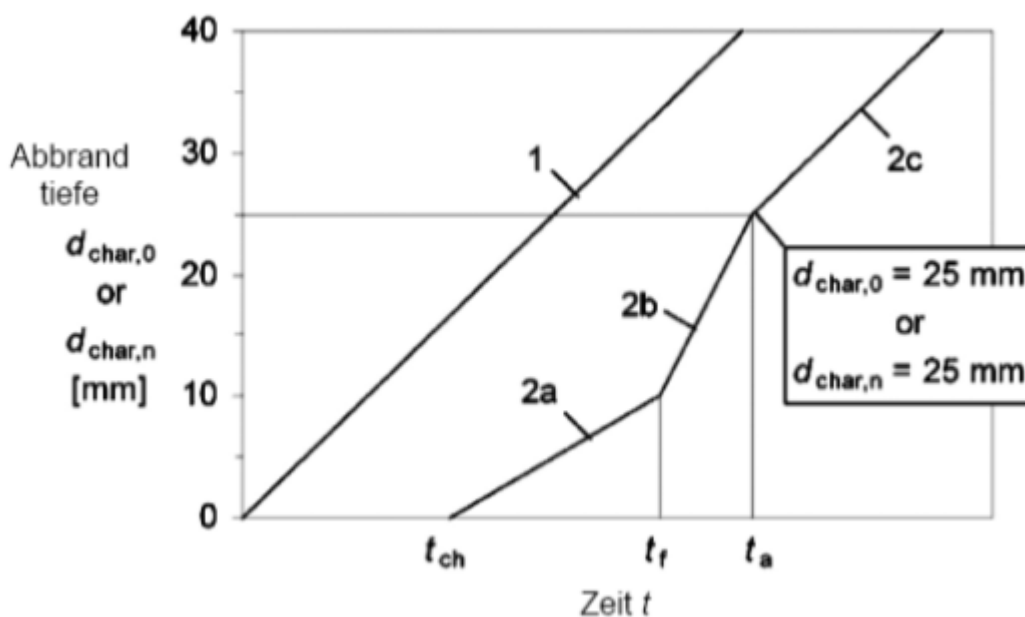

Figure 6: Representation of charring depth as a function of time for $t_f > t_{ch}$ for gypsum boards type F and DF or GKF planked woods, source: [ÖNORM EN 1995-1-2]

For gypsum plaster fire protection boards (GKF) and gypsum fiberboards, no failure time points t_f (boards coming off) were available, thus dimensioning was possible only with limitations. Based on investigations by Holzforschung Austria [Teibinger and Matzinger 2010], the following failure times were included in [ÖNORM B 1995-1-2] for these boards:

Equation 3-1: Wall: $t_f = 2,2 \cdot h_p + 4$

t_f : failure time [min]

Equation 3-2: Floor: $t_f = 1,4 \cdot h_p + 6$

h_p : cladding thickness [mm]

Values were determined from experimental results of clad timber frame elements. They are to be used for cross-laminated timber elements with suspension or facing shells. In case of directly clad cross-laminated timber elements, these values may be used where distinctly higher failure times may be expected in this case. Single experiments have shown that failure time t_f for cross-laminated timber elements directly clad with GKF may be higher by up to 200% than with timber frame components.

3.4.3 Structural design of load-bearing capacity R of cross-laminated timber elements

Due to a heating of wood, mechanical properties are diminished in the temperature range between 25°C and 300°C. For this reason, the two simplified methods of calculation - method of reduced cross sections and method of reduced properties - are shown besides a detailed calculation in [ÖNORM EN 1995-1-2]. The use of the method of reduced cross sections with a factor of $k_0 \cdot d_0$ for the determination of the ideal burn-up depth has taken root in Austria. The value for d_0 stated in the current standard and taken from the simplified method of calculation of the method with reduced cross sections is currently under international discussion.

3.4.4 Design of the integrity EI of cross-laminated timber elements

The integrity EI can be verified for cross-laminated timber elements according to the model, which was elaborated by [Schleifer 2009], as stated in [ÖNORM B 1995-1-2]. This model offers the possibility of extending it with other materials as well as a wider range of calculable superstructures, contrary to the method calculation according to Annex E [ÖNORM EN 1995-1-2]. This model has been designed for fire resistance periods of up to 60 minutes. Validation calculations using large scale fire tests carried out by [Teibinger and Matzinger 2010] demonstrate that this model can be used for up to 90 minutes.

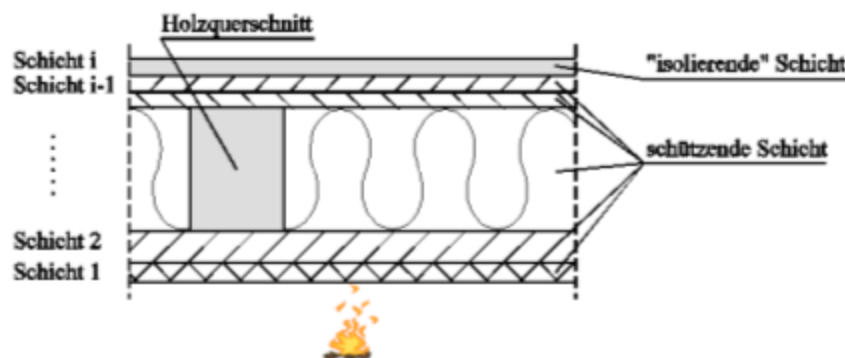

Figure 7: Classification of material layers, source: [Schleifer 2009]

The component may be arbitrarily composed of the following panels and insulations and implemented with a hollow space where it can be extended by additional construction materials at any time if the thermal properties under ETK (Einheitstemperaturkurve, standardized temperature curve) load are available:

Panels (mounting according to manufacturer's instructions):

- Timber boards of strength class C24 according to [ÖNORM EN 338]
- OSB panels according to [ÖNORM EN 300]
- Fiberboards according to [ÖNORM EN 309]
- Gypsum plaster boards type A, type H and type F according to [ÖNORM EN 520]
- Gypsum fiberboards [ÖNORM EN 15283-2]

Insulation (mounting with oversize according to manufacturer's instructions):

- Mineral wool according to [ÖNORM EN 13162]
- Glass wool according to [ÖNORM EN 13162]

Insulation has to be secured to prevent it from falling out; otherwise insulation should not be considered in calculations. For cross-laminated timber elements, the context of timber boards may be assumed.

In this model, compliance with the temperature criterion I ("isolation") is verified, based on material investigations and simulation calculations. To this end, components are divided into protective component layers and the insulating component layer (the last layer on the side away from the fire). In this model, it is assumed that the protective layers fail at a temperature of 270°C on the side away from the fire and drop. This assumption is true for wood materials. For gypsum plaster boards, the delayed point of time of falling off is considered by using the difference in time Δt_i .

Time t_{ins} to the loss of the integrity function of the wood component results from the sum of protective times of individual component layers and insulation time of the last layer.

Equation 3-3: $t_{ins} = \sum t_{prot,i-1} + t_{ins,i}$

t_{ins} : time to loss of integrity function [min]
 $t_{prot,i}$: protective time of layer i [min]

$t_{ins,i}$: insulation time of layer i [min]

Protective times $t_{prot,i}$ and insulation times $t_{ins,i}$ are composed of a material-dependent bottom time, position and joint coefficients. Position coefficients consider the impact of construction materials positioned in front or behind on the failure time of the material concerned. The impact of the material layer in front is expressed by $k_{pos,exp,i}$ and the impact of the material layer behind is expressed by $k_{pos,unexp,i}$. Joint coefficients $k_{j,i}$ consider the impact of joints.

Equation 3-4: $t_{prot,i} = (t_{prot,0,i} \cdot k_{pos,exp,i} \cdot k_{pos,unexp,i} + \Delta t_i) \cdot k_{j,i}$

$t_{prot,i}$: Protection time of layer i [min]

$k_{pos,exp,i}$: Position coefficient for the examined layer i, resulting from the layers in front of it [-]

$k_{pos,unexp,i}$: Position coefficient for the examined layer i, resulting from the layers after it [-]

$k_{j,i}$: Joint coefficient [-]

Equation 3-5: $t_{ins,i} = (t_{ins,0,i} \cdot k_{pos,exp,i} + \Delta t_i) \cdot k_{j,i}$

$t_{ins,i}$: Protection time of layer i [min]

$k_{pos,exp,i}$: Position coefficient for the examined layer i, resulting from the layers in front of it [-]

Δt_i : Time difference that is added to the insulation or protection time [min]

$k_{j,i}$: Joint coefficient [-]

Characteristics of individual bottom times and coefficients can be found in [ÖNORM B 1995-1-2].

3.5 Facades

With facade fires, it is necessary to distinguish different causes for their development, e.g. inside a building with an opening to the outside (fire transfer through flash-over) or fire outside a building immediately adjacent to the facade or that of the neighboring building (fire spread). In case of a fire at a facade from building class 4, the defined protection objective has to be considered. When the reaction-to-fire performance of facades is examined while assuming a fire burnout from a window, this simultaneously represents an examination of flammability and fire resistance and is tested according to [ÖNORM B 3800-5].

The following protection objective has been defined in cooperation with the authorities:

"The fire protection objective in building regulations at the building external wall is to prevent fire from spreading over more than one story above where the fire broke out. Hazards to persons escaping and rescue workers due to large parts of dropping facade parts must be excluded."

3.6 Legal Requirements

3.6.1 General

In the OIB guideline 2 in conjunction with guidelines 2.1, 2.2 and 2.3, the Austrian Institut für Bautechnik (OIB) elaborated requirements concerning fire protection as a basis of harmonization in the third edition [OIB Guideline 2 2015]. Currently, the states of Burgenland, Land of Carinthia, Salzburg, Styria, Tyrol, Vorarlberg and Vienna have adopted regional construction laws. Graphic treatments of requirements depending on building classes can be taken from [Teibinger 2011]. Basically, the OIB guideline allows wood buildings of up to six stories. Generally, a fire resistance of components of 60 minutes is required. Components that form fire compartments need to have a fire resistance of 90 minutes, while components of the top story have to have a fire resistance of 30 minutes.

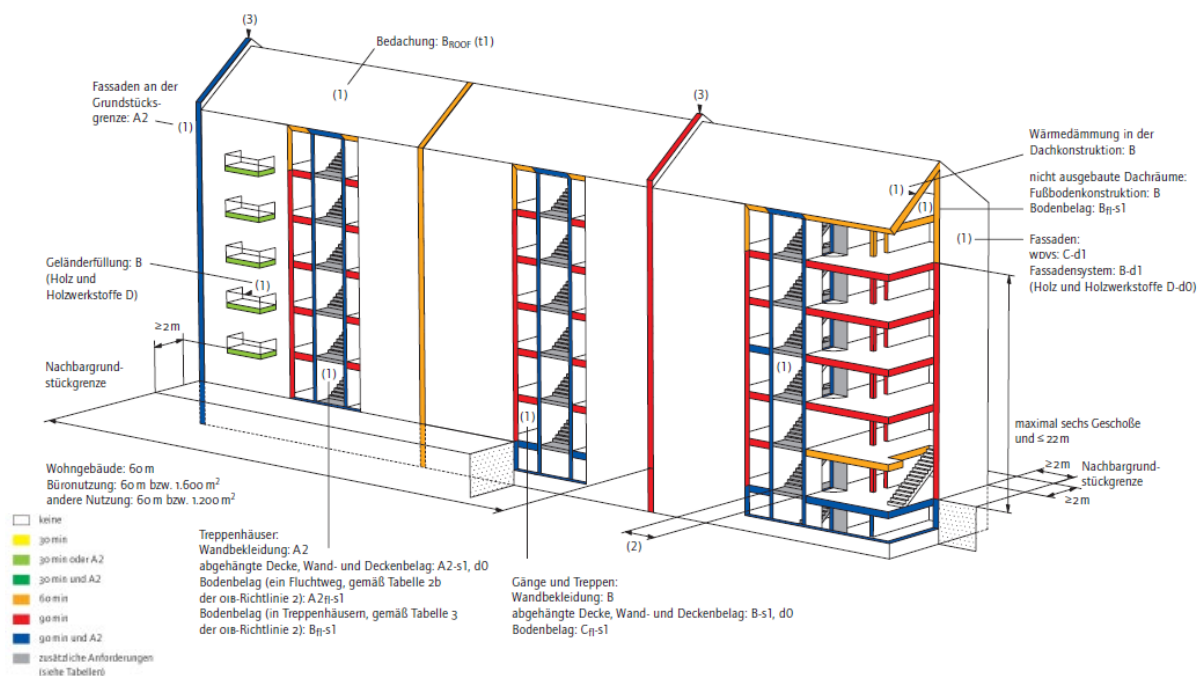

Figure 8: Requirements for fire resistance and reaction-to-fire performance with buildings of building class 5, source: proholz/HFA

3.6.2 Fire compartments

For the effective restriction of fire and smoke inside buildings, the OIB guideline 2 defines a maximum length of 60m, whilst the maximum net floor area and number of floors was omitted for residential buildings. For properties with office use the maximum net floor area is 1600m² and for other uses its 1200m². Fire compartments must not span more than four stories above ground. Up to building class 5 (maximum escape level 22m; maximum 6 stories above ground), components made of wood with a fire resistance of 90 minutes that form fire components may be erected.

Doors, windows and other openings in external walls that verge on walls forming fire compartments need to have a distance from their center of at least 0.5m if the horizontal fire transmission cannot be constrained by equivalent means. This distance has to be increased to at least 3m if the angle of external walls at their fire-compartment forming wall is less than 135°. Required distances may be reduced if the horizontal spread of fire can be restricted by equivalent measures.

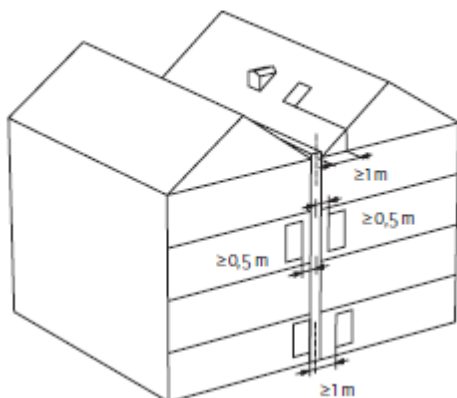

Figure 9: Requirements for openings in roofs and external walls. Source: proholz/HFA

Unless equivalent measures are taken to restrict the spread of fire, roof openings, such as pitched roof windows, dormers, must be measured horizontally at least 1 m from the center of the wall forming the fire compartment. If ceilings delimit fire compartments on top of each other, there must be a ceiling-overlapping outer wall strip of at least 1.2 m height in EI 90 or a cantilever of the fire compartment-forming ceiling of at least 0.8 m.

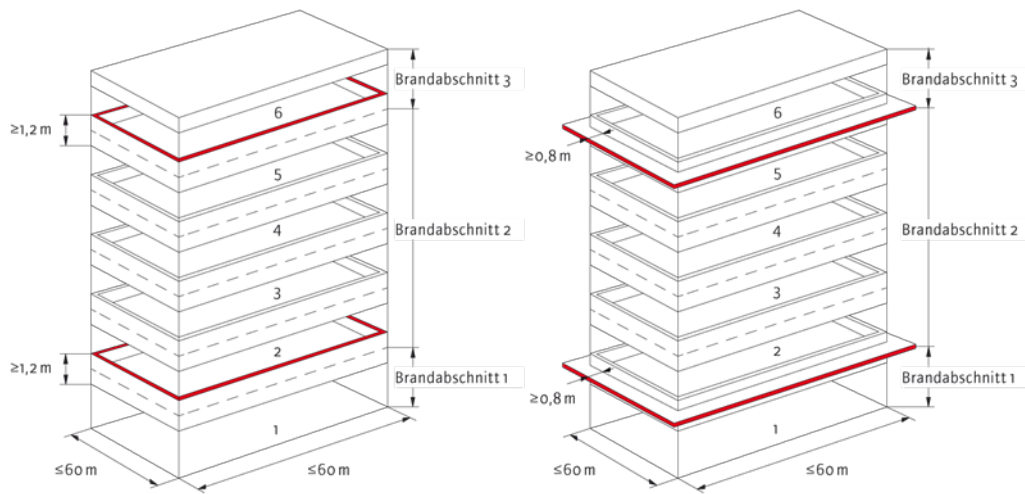

Figure 10: Requirements for fire compartments and external wall strips extending across the ceiling in buildings with a maximum of six floors above ground (not residential buildings). Source: proholz/HFA

For buildings of GK 5 with more than six floors above ground (not residential buildings), a non-combustible outer wall strip across the ceiling is required. The requirements for the fire compartments and the ceiling-overlapping outer wall strips in residential and non-residential buildings can be found in Figure 11

Walls that form fire compartments must have a fire resistance of 90 minutes and are at least 15 cm above the roof, unless other measures restrict the spread of the fire. Details can be found in Section 8.6.

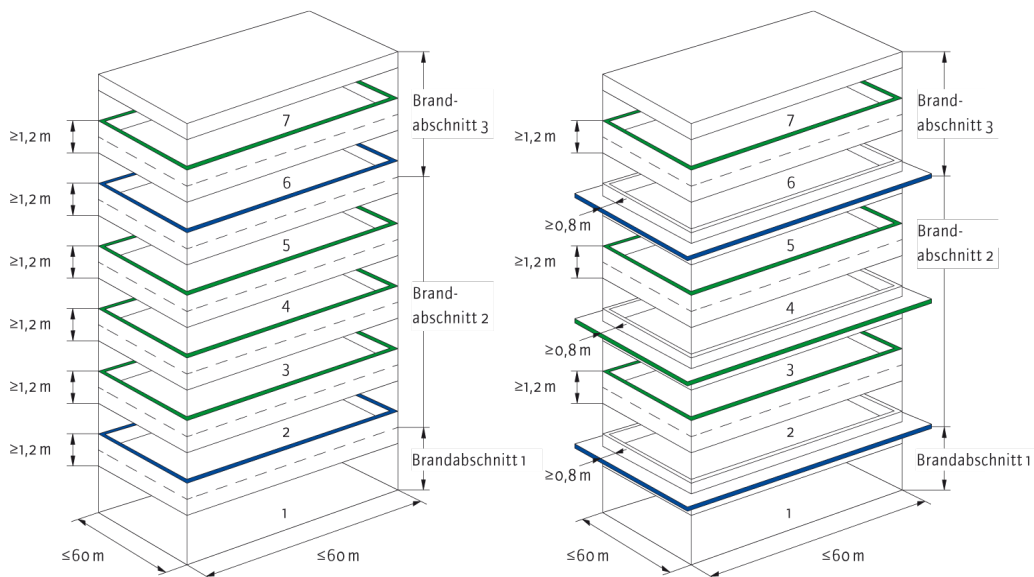

Figure 11: Requirements for fire compartments and cross-ceiling external wall strips for GK 5 with more than six floors above ground (not residential buildings)

3.6.3 Facades

OIB guideline 2 "Fire Protection" 2015 edition requires that for buildings from building classes 4 and 5, facades are to be designed in such a way that fire can spread over the facade surface within 30 minutes to the second story above the source of the fire, large facade parts can fall down and there is a risk of People is effectively restricted. Curtain walls can be ventilated, ventilated or non-ventilated. From building class 4, evidence must be provided as to whether the construction corresponds to the protection goals.

Wooden facades are permitted up to six-story buildings, provided the insulation corresponds to fire behavior class A2 and floor-to-floor fire seals in accordance with ÖNORM B 2332 are installed. Design-free constructions for buildings from building class 4 are those that have a fire protection barrier between the stories that protrudes at least 20 cm from a continuous profile made of sheet steel (minimum thickness 1 mm) or equivalent in terms of fire protection, see Section 8.10.2.

In the case of free-standing buildings of building class 4, which are accessible from the outside on at least three sides for firefighting, fire protection barriers can be dispensed with in accordance with OIB guideline 2 if the insulation layer is A2 and the fasteners and connecting elements have a melting point of at least 1,000 ° C (e.g. steel, stainless steel) and the outer layer is made of A2, B or made of wood and wood-based materials in D and any rear ventilation gap is not more than 6 cm wide.

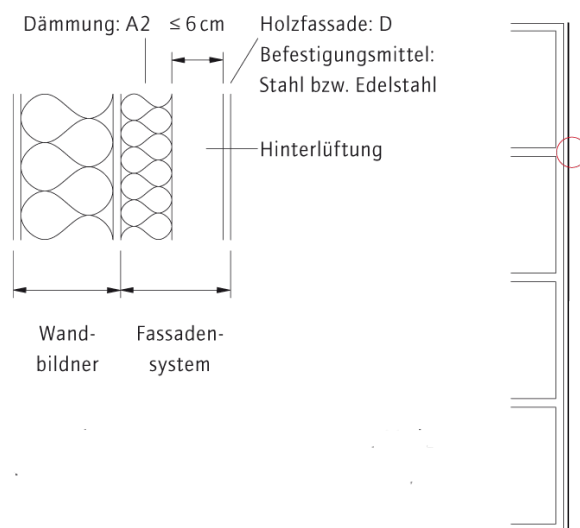

Figure 12: Requirements for GK 4 wooden facades of free-standing buildings that are accessible from the outside on at least three sides for firefighting. Source: proholz/HFA

In the case of external wall thermal insulation composite systems with an insulation of a maximum of 10 cm EPS or made of building materials of class A2, the protection goal according to the OIB guideline is considered to be fulfilled. In the case of external wall thermal insulation

composite systems with an insulation material of class E of more than 10 cm, there are fire protection bulkheads made of mineral wool with a height of 20 cm in the area of the ceiling in the area of the ceiling or in the lintel area of the windows and French doors fire protection bulkheads made of mineral wool with a lateral overlap of 30 cm and a height of 20 cm glued and dowelled. In addition, additional requirements apply in the areas of passageways, passageways and arcades.

In addition, the OIB guideline 2 regulates requirements for the fire behavior of the building materials of facades.

Table 8: Requirements to the reaction-to-fire performance of facades according to [OIB Guideline 2 2015]

Building classes (GK)	GK 1	GK 2	GK 3	GK 4	GK 5	
					<6 above ground stories	>6 above ground stories
1 Facades						
1.1 External wall heat insulation composite system	E	D	D	C-d1	C-d1	C-d1
1.2 Facade systems, hanging with an air space, ventilated or without an air space						
1.2.1 Classified overall system or	E	D-d1	D-d1	B-d1 ⁽¹⁾	B-d1 ⁽¹⁾	B-d1 ⁽²⁾
1.2.2 Classified individual components	E	D	D	A2-d1 ⁽²⁾	A2-d1 ⁽²⁾	A2-d1 ⁽³⁾
External layer	E / E	D / D	D / A2	D / A2	D / A2	D / A2
Substructure rod like/point-shaped	E	D	D	B ⁽²⁾	B ⁽²⁾	B ⁽³⁾
Insulation layer or heat insulation						
1.3 Other claddings of external walls or coverings	E	D-d1	D-d1	B-d1 ⁽⁴⁾	B-d1 ⁽⁴⁾	B-d1
1.4 Building separation joint material	E	E	E	A2	A2	A2
1.5 Railing infill with balconies, loggias and the like	--			B ⁽⁴⁾	B ⁽⁴⁾	B

(1) Wood and wooden materials are admissible in D if the classified overall system complies with class D-d0.

(2) In case of an insulation layer / heat insulation in A2, an external layer in B-d1 or made of wood and wooden materials are admissible in D.

- (3) For an insulation layer / heat insulation in A2, an external layer is admissible in B-d1; in buildings having not more than five stories above ground and an escape level of not more than 13m, wood and wooden materials are admissible in D for an insulation layer / heat insulation in A2.
- (4) Wood and wooden materials are also admissible in D.

3.6.4 Penetrations

Regarding requirements to penetrations in construction components, Section 3.4 of [OIB Guideline 2 2015] requires:

If shafts, conduits, pipes and other installations are in walls or floors or penetrate them, appropriate measures (e.g. partitions, sheathing) have to that the transmission of fire and smoke beyond the required fire resistance class is effectively restricted.

Partitions used for penetrations have to exhibit the same fire resistance period as the components.

Table 9: Requirements for fire-retarding sealings in stories above ground according to [OIB Guideline 2 2015]

Building class (GK)	Requirements for fire resistance
GK 2	30 minutes
GK 2 between apartments or operational units in town houses	60 minutes
GK 3 and GK 4	60 minutes
GK 2, GK 3, GK 4 and GK 5 (≤ 6 above ground floors) components forming fire compartments	90 minutes
GK 5 (> 6 above ground floors) components forming fire compartments	90 minutes and A2

3.7 Deviations

It is possible to deviate from the requirements of the OIB guideline, provided that a fire protection concept, which is to be drawn up in accordance with the OIB guideline, proves that the same level of protection can be achieved as when the guideline is applied. It is advisable to clarify the compensation measures in advance with the responsible building authority. Fire protection concepts may only be created by experts with fire protection training and experience. As compensation measures, reductions in the fire compartments, structural measures such as encapsulation of the wooden structures and technical measures such as fire alarm systems or extinguishing systems can be used.

4 Sound protection basics

4.1 General

Sound protection:

- Insufficient sound insulation and impairment due to noise can have negative impacts on health.
- The sensitivity of the human auditory system is frequency-dependent, wherein the auditory system has its highest sensitivity at about 4000 Hz.
- Since the human ear does not perceive the volume linearly to the sound pressure, the sound pressure level is defined proportional to the common logarithm of the sound pressure.
- Level doubling or two sound sources with the same emission level, resp., result in an increase by 3 dB ($50 \text{ dB} + 50 \text{ dB} = 53 \text{ dB}$).
- An increase by 10 dB is caused by 10 sound sources with the same level ($50 \text{ dB} + 50 \text{ dB} + 50 \text{ dB} + 50 \text{ dB} + 50 \text{ dB} + 50 \text{ dB} + 50 \text{ dB} + 50 \text{ dB} + 50 \text{ dB} + 50 \text{ dB} = 60 \text{ dB}$).
- Sound transmission by flanking components must be considered, if necessary, decoupling or elastic intermediate layers, resp., must be used.
- Timber construction fulfils the requirements to sound insulation. A variety of tested solutions (e.g. <http://www.dataholz.com>) is available.

Sound is defined as mechanical vibrations that propagate in elastic media by oscillations of mass particles about their rest position causing compactions and thinning in the medium. While sound waves propagate in air only in form of longitudinal waves (compaction in the direction of propagation), sound occurs in solid bodies in various forms of waves. These are mainly transversal or Rayleigh waves where shear stresses are created by oscillations perpendicularly to the direction of propagation; moreover, there are bending waves that result from bending movements and thus from associated compression and expansion in the direction of propagation. Bending waves are of greatest importance for buildings as they exhibit maximum airborne sound emissions.

Noise is disturbing sound which may have various causes and can be detrimental to health. The task of building physics now is to reduce this unwanted sound to an acceptable level by sound insulation. This requires appropriate knowledge of the sound properties of components, the physical nature of sound and the relevant frequency range, see Figure 13.

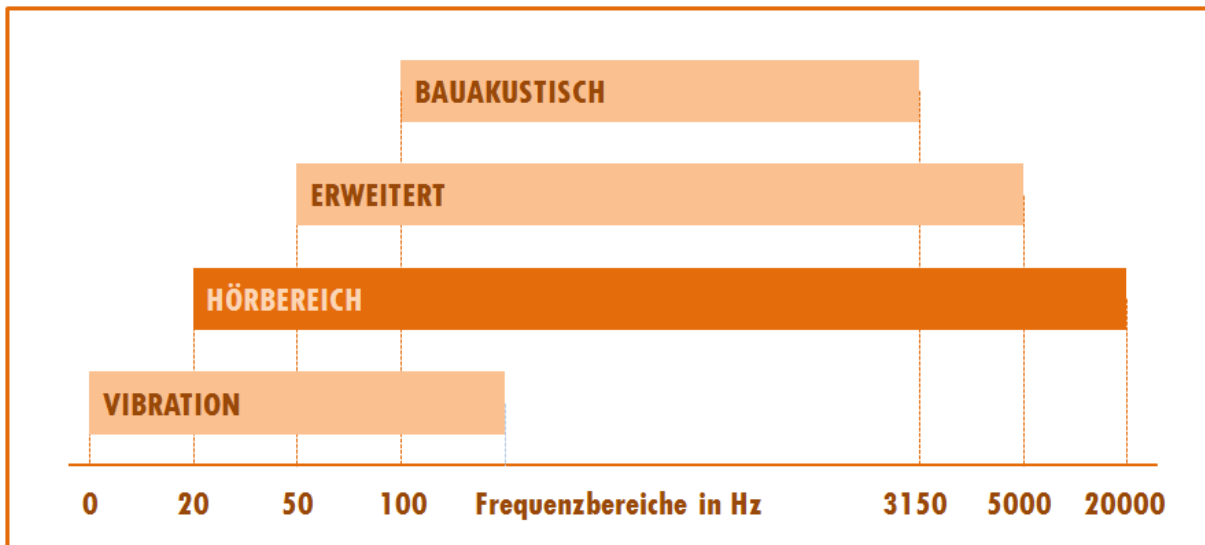

Figure 13: Relevant frequency ranges in building acoustics

It is to be noted that the sensitivity of human auditory system depends on frequency. The sense of hearing shows its maximum sensitivity at about 4000 Hz. Towards lower and higher frequencies, sensitivity greatly decreases, thus for the same volume perceived at very low or very high frequencies, it requires a multiple of the sound pressure level. This can be clearly seen from the curves of equal volume, see Figure 14.

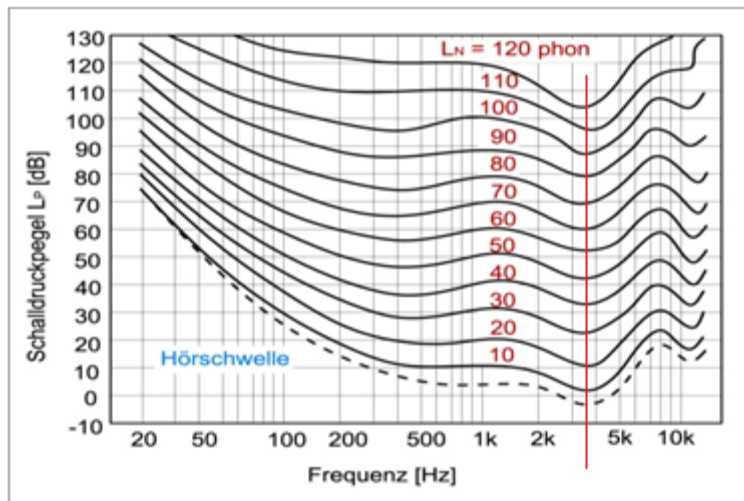

Figure 14: Curves of equal volume [Fasold et al. 2003]

4.1.1 Calculation basics in acoustics

Due to the extraordinary acoustic properties of the human ear and the limited display options on paper for value ranges that include several powers of ten, sound pressures are usually converted into levels for their display according to Equation 4-1.

Equation 4-1: $L = 10 \log \frac{p^2}{p_0^2} \text{ Pa}$

L: sound level [dB]

p: sound pressure [Pa]

p₀: hearing threshold [Pa]

Compared to the atmospheric pressure of approx. 100 kPa, the sound pressure range is an extremely small pressure fluctuation, which can be found in the order of magnitude of the hearing threshold with 20 µPa and the pain threshold with approx. 20 Pa. This level display means that sound events can no longer simply be added but must be converted into sound pressures according to equation 4-2 before adding them. L_{ges} is the sound level in dB and p_{ges} is the sound pressure in Pa, resulting from both sound sources.

Example:

30 dB + 30 dB ≠ 60 dB, rather:

Equation 4-2: $L_{ges} = 10 \log \frac{p_{ges}^2}{p_0^2} = 10 \log (2 \cdot 10^{\frac{30}{10}}) = 10 \log (10^{\frac{30}{10}}) + 10 \log (2)$

30 dB + 30 dB = 33 dB

Doubling of sound level or two sound sources of equal level result in an increase of 3dB.

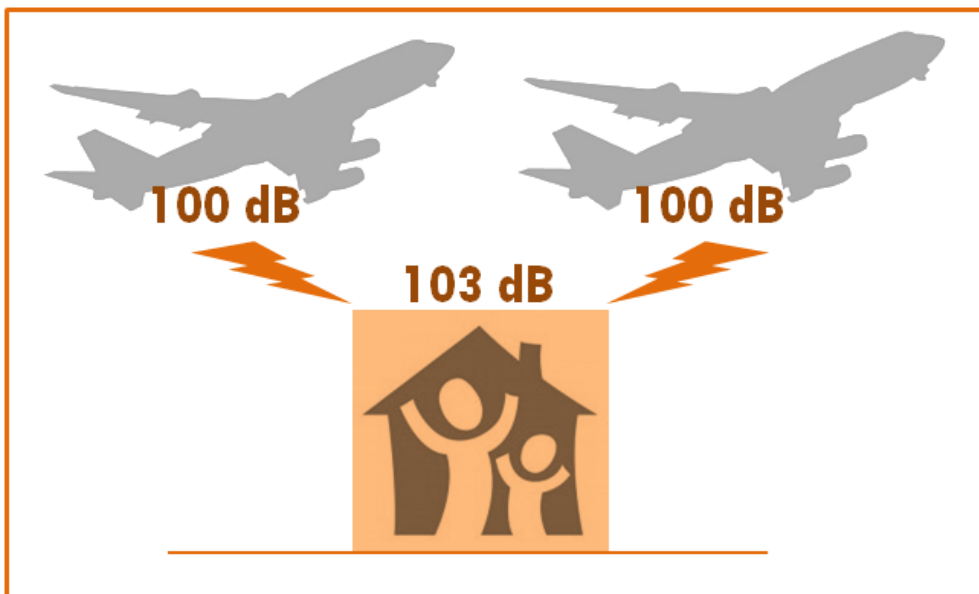

Figure 15: Level doubling results in a 3dB increase of the total sound level

4.1.2 Assessment in building acoustics

Sound insulation of construction components is determined without any weighting, thus linearly. Weighting is done by ascertaining individual data. In this weighting process which is done according to [ÖNORM EN ISO 717-1] for air-borne sound and [ÖNORM EN ISO 717-2] for impact sound, a reference curve is shifted until a higher deviation or a lower deviation by the measured curve is on average 2 dB per third or overall 32 dB maximum. The value of the shifted reference curve at 500 Hz is the single-number value required. The frequency range where the

unfavorable deviations occur is an indication of where the individual construction weak point is. So-called spectrum adaptation values supplement the information content of individual data through deviating weighting curves und partly frequency ranges and thus allow additional statements on levels versus frequency and a more precise determination of strong and weak points of the construction.

The result of the evaluation is a single value with spectrum adjustment values (n) in brackets, which are added to the single value. The acoustic parameter itself signals (in contrast to the frequency curve) with a subscript w that the result is evaluated.

Example:

$$R_w (C, C_{tr}) = 45 (0, -2) \text{ dB}$$

In the example, the weighted sound reduction index is 45 dB, the spectrum adjustment value $C = 0$ dB, $R_w + C$ is therefore also 45 dB, the spectrum adjustment value C_{tr} is -2 dB, $R_w + C_{tr}$ is therefore 43 dB.

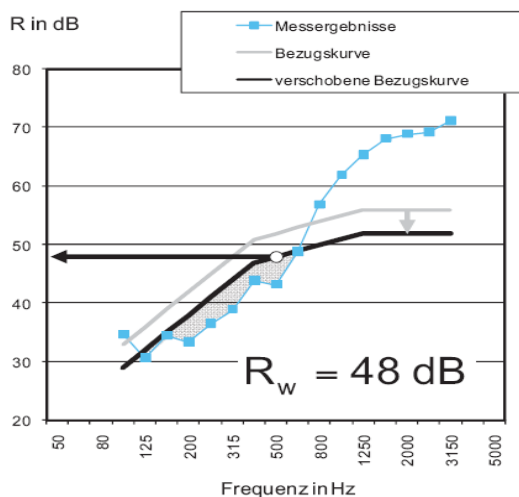

Figure 16: From R to R_w - process of single number evaluation of the sound reduction index [Riccabona et al. 2010]

4.2 Protection against airborne noise

Basically, a component is stimulated by air-borne or impact sound, which results in emissions of air-borne sound in adjacent rooms. In case of airborne sound insulation, the component is stimulated by airborne sound waves. It is indicated by the sound insulation value R. This is defined as ten times the common logarithm of incident P_1 divided by the emitted sound power P_2 (Equation 4-3).

$$\text{Equation 4-3: } R = 10 \log \frac{P_1}{P_2} \text{ dB}$$

R: sound reduction index [dB]

P_1 : incident sound power [W]

P_2 : emitted sound power [W]

The sound reduction index R is the quantity that is also used to describe the sound insulation properties of components.

Other quantities are used for the description of sound insulation in buildings, which also include sound transmission via indirect paths. An overview of this is shown in Figure 17.

The sound insulation index R is normalized to the component area S and indicates with a dash that it is a building sound insulation index (R'), which also includes the bypass transmission. The Austrian standard requirements for interior components are defined for the construction situation in the building using the weighted standard sound level difference $D_{nT,w}$ (Equation 4-4), which is standardized to a reference reverberation time T_0 for apartments in the reception room of 0.5 s. This corresponds most closely to the conditions in living rooms and is therefore preferred to the weighted standard sound level difference $D_{n,w}$ based on a reference absorption area of 10 m².

Equation 4-4: $D_{nT} = L_S - L_E + 10 \log \frac{T}{T_0}$ dB

D_{nT} : standard sound level difference [dB]

L_S : sound level in the sending room [dB]

L_E : Sound level in the receiving room [dB]

T : reverberation time [s]

T_0 : reference reverberation time [s], i.a. 0,5 s

LUFTSCHALL		S	T/T ₀	A/A ₀
Bauteil	R _w			
Gebäude	R' _w			
	D _{n,w}			
	D _{nT,w}			

BAUTEIL

GEBÄUDE

R_w: weighted sound reduction index [dB]

R'_w: rated building sound insulation index [dB]

D_{n,w}: weighted norm sound level difference [dB]

D_{nT,w}: weighted standard sound level difference [dB]

S: area of the partition member [m²]

T: reverberation time [s]

T₀: reference reverberation time [s], i.a. 0,5 s

A: equivalent sound absorption area [m²]

A_0 : Reference absorption area [m²], i.a. 10 m²

Figure 17: Evaluated building caustic parameters airborne sound, their application and standardization

These building acoustics parameters, also called descriptors, can also be converted into one another, as they are related to the room geometry, based on the “Sabine formula”.

T: reverberation time [s]

Equation 4-5: $T = 0,163 \cdot \frac{V}{A}$ in s

V: room volume [m³]

A: equivalent sound absorption area [m²]

More detailed information on this can be found in the relevant literature if required.

The evaluated resulting building sound insulation measure $R'_{res,w}$ is a special case. It is applied to facades, taking into account the area proportions and the sound insulation measures of the individual components, such as walls and windows. It is to be dimensioned separately for day and night depending on the location-related and, if applicable, component-related external noise level.

$R'_{res,w}$: evaluated resulting building sound reduction index [dB]

Equation 4-6: $R'_{res,w} = -10 \log \left[\frac{1}{S_g} \sum_i S_i 10^{\frac{-R_i}{10}} \right]$ in dB

S_g : total area of all components [m²]

S_i : Area of the individual components [m²]

R_i : Building sound insulation index of individual components [dB]

4.2.1 Airborne sound insulation of single-leaf solid components

The airborne sound insulation of single-leaf, solid components shows the frequency response represented in Figure 18 where three different characteristic portions can be distinguished.

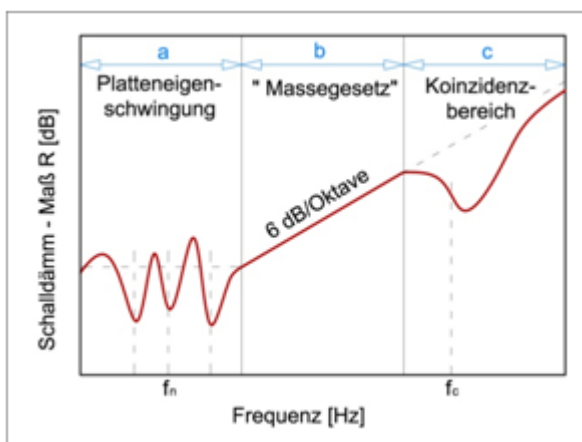

Figure 18: Characteristic portions of airborne sound insulation of single-leaf components

Natural resonances of components are usually of minor importance as they appear only at very low frequencies due to the common space dimensions in buildings. Resonance frequencies f_n of a supported slab can be calculated using the bending rigidity B' with regard to slab width, the area-related mass m' and the slab's lateral lengths.

On principle, the airborne sound impacting on a slab creates forced bending waves. If the wavelength of bending waves enforced by the airborne sound wave field equals that of free slab bending waves, wave fields are coupled, see Figure 19.

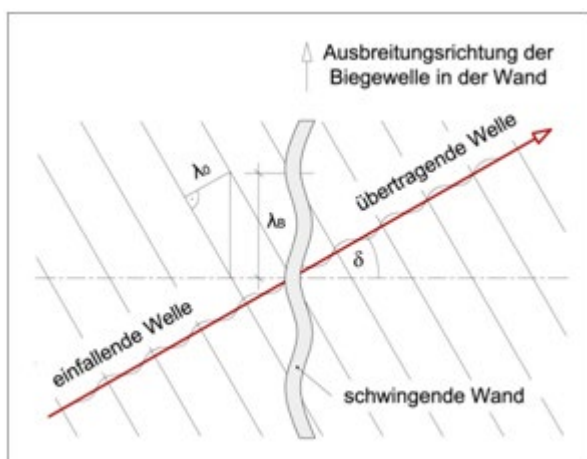

Figure 19: Coincidence

This can lead to a resonance which results in lower sound insulation. Coincidence is meant to be the accordance in time and space of the slab's waveform and that in air in front of the slab.

It should be noted that the velocity of bending waves is dependent on frequency which entails the occurrence of coincidence from a certain coincidence cutoff frequency f_c .

The drop of sound insulation at the coincidence frequency is practically limited by the loss factor η with the result that there is usually only a horizontal plateau in the frequency response. Sound insulation in the frequency range above the coincidence frequency increases again with 6dB per octave.

4.2.2 Airborne sound insulation of additional-leaf light components (timber frame construction)

While the airborne sound insulation of single-leaf solid components depends on the area-related mass m' can be determined in a relatively easy way, there are various effects occurring at lighter and often multi-leaf wood constructions that influence sound insulation in characteristic ways.

A multi-leaf construction is an oscillating system of two or more masses connected by a spring with a characteristic dynamic rigidity s' . Void spaces or elastic intermediate layers take the role of a spring. An essential factor for sound insulation of a construction of this type is leaf coupling. The lower this coupling, the less energy can be transferred from one leaf to another and the

better the sound insulation of the overall structure is. Figure 20 shows the typical frequency response of the sound reduction index of multi-leaf components with three characteristic portions.

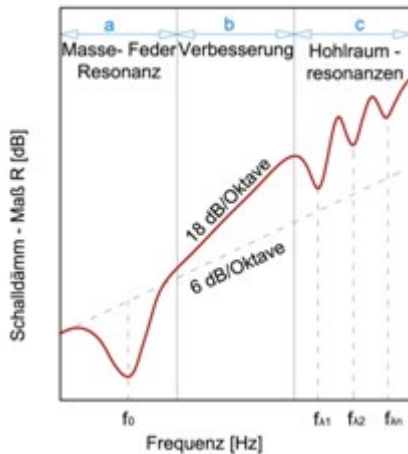

Figure 20: Sound reduction index of double-leaf components

Such systems have a resonance frequency with maximum amplitude which is determined by mass, spring, distance between masses and friction (attenuation) [Lehrbuch der Bauphysik 2008].

In the range of resonance frequency, a drastic reduction of sound insulation occurs. This entails that the sound insulation in the low frequency range can drop below that of a single-leaf wall having the same mass. Above the spring-mass resonance, sound insulation increases.

At higher frequencies, there are cavity resonances that can be attributed to standing waves in the cavity and also reduce sound insulation. Their impact is, however, low if the cavity is filled with sound absorbing material [Fasold und Veres 2003].

With multi-leaf components, the track adaptation effect (coincidence) occurs only at higher frequencies due to the considerably lower bending rigidity B' of common covering materials. Because of usually quite high sound insulation of multi-leaf light components in this frequency range, the drop of sound insulation near the coincidence frequency commonly shows no high impact on the overall result.

4.2.3 Airborne sound insulation of single-leaf, solid, but light components (solid timber constructions)

Solid timber constructions have a special feature in that they can be assigned neither to heavy, solid components, nor to light, multi-leaf ones. While with heavy solid components sound insulation requirements are met through their mass and in timber frame constructions through flexible coverings, solid timber plates are neither a flexible, nor a rigid structure [Bednar et al. 2000].

As has been explained, sound insulation drops near the coincidence frequency. This can be observed with heavy components in the very low frequency range and with light multi-leaf components in the very high frequency range. In both cases outside the frequency spectrum that is important for building acoustics. As is apparent in Figure 21, the coincidence for common construction thicknesses is in the range from 250 to 500 Hz and thus in the frequency range of practical importance. This is a fact that needs to be considered in planning of the whole component structure.

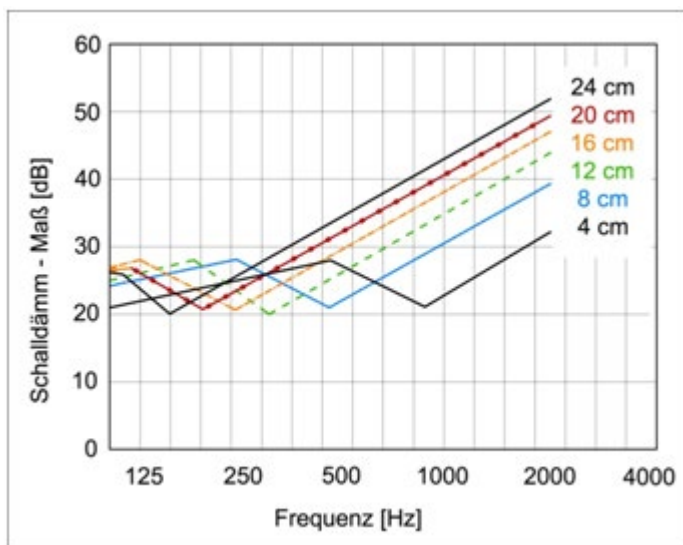

Figure 21: Calculated sound insulation index of jointless solid timber slabs depending on their thicknesses, source: [Bednar et al. 2000]

Building practice solutions for cross-laminated timber constructions are discussed in Section 0.

4.3 Structure-borne sound

4.3.1 General

Structure-borne sound is induced in a component by mechanical excitation. In the reception room, structure-borne sound is emitted as airborne sound, too. Impact sound is a special type of structure-borne sound that is caused by walking on the component as well as the usual use in an apartment, such as moving furniture. Contrary to air-borne sound insulation, the starting point is the defined excitation of impact sound (by a standardized tapping machine) and not a sound level difference, but a maximum sound level in the reception room L_2 is specified.

The impact sound absorbing subflooring of a component is indicated by the standardized impact sound level L_n related to a reference absorption area. The building situation is indicated by an apostrophe, too, which shows that it is an impact sound level in situ. Standard requirements are defined by a weighted standard impact sound level $L'_{nT,w}$ (Equation 3-3), which is related to the reference reverberation period T_0 , just like the standard sound level difference.

Equation 4-7: $L'_{nT} = L_E - 10 \log \frac{T}{T_0} - T$ dB

L'_{nT} : standard impact sound level in situ [dB]
 L_E : sound level in the reception room [dB]
 T : reverberation time [s]
 T_0 : reference reverberation time [s], i.a. 0,5 s

Equation 4-7: $L'_{nT} = L_E - 10 \log \frac{T}{T_0}$ dB

L'_{nT} : standard impact sound level in situ [dB]
 L_E : sound level in the reception room [dB]
 T : reverberation time [s]
 T_0 : reference reverberation time [s], i.a. 0,5 s

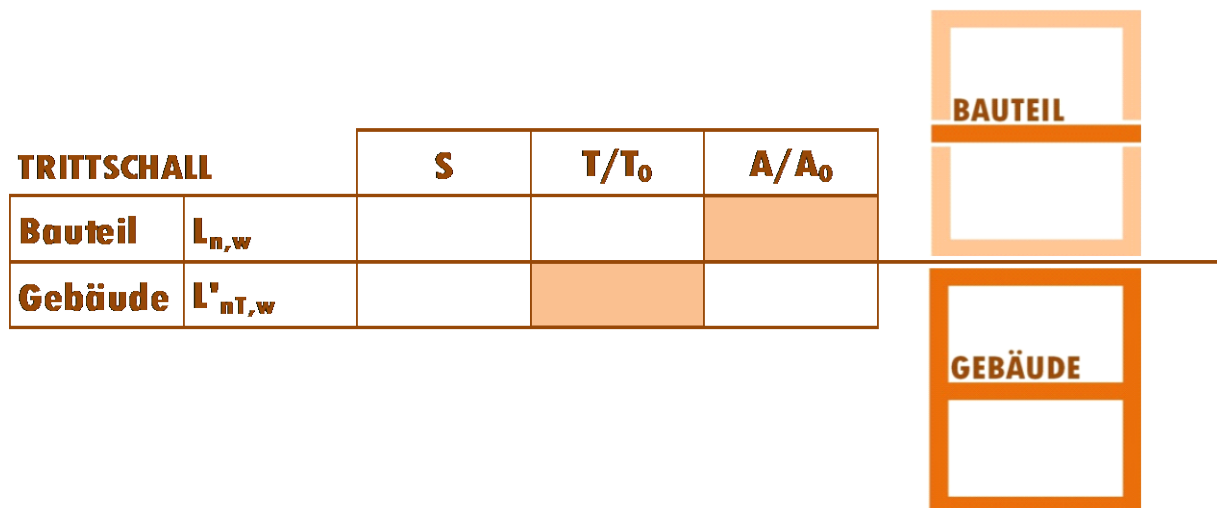

$L_{n,w}$: weighted norm impact sound level [dB]
 $L'_{nT,w}$: weighted standard impact sound level [dB]
 S : area of the partition member [m²]
 T : reverberation time [s]
 T_0 : reverberation time [s], i.a. 0,5 s
 A : equivalent sound absorption area [m²]
 A_0 : reference absorption area [m²], i.a. 10 m²

Figure 22: Evaluated building caustic parameters, impact sound, their application and standardization

4.3.2 Reduction of structure-borne sound

It is essentially attempted to minimize the introduction of impact sound into the structure, its propagation and emission as airborne sound. The introduction of impact sound in buildings is prevented by design means through corresponding floor covers, such as floating floor screed, and transfer through breaks in material and construction details, such as mounting on elastic intermediate layers, and the installation of damping layers. The emission into the reception room can be reduced through shells or generally flexible coverings, see Figure 23.

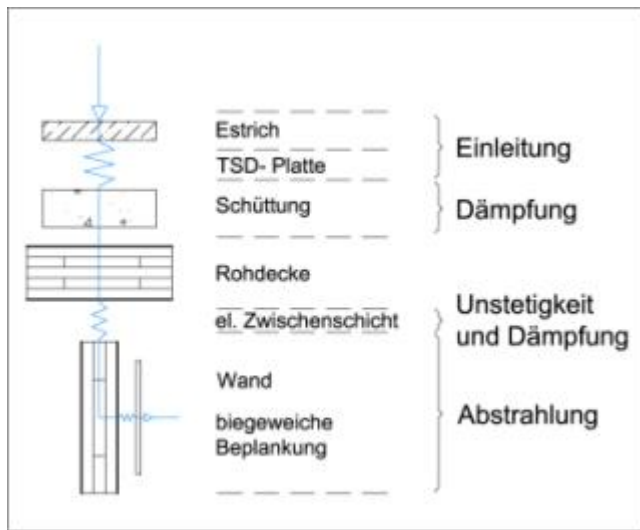

Figure 23: Reduction of impact sound

Building practice solutions for cross-laminated timber constructions are discussed in Section 0.

4.3.2.1 Floating floor screed

The insulation effect of a screed ΔL is defined by the fact that the standard impact sound level $L_{n,w}$ of a floor is measured in dependence on frequency, once without screed, thus only the raw floor with its standardized impact sound level $L_{n,eq}$, and once with screed L_n , where the difference is designated improvement or impact sound reduction ΔL . Weighting across the frequency range from 100 to 3150Hz results in the weighted impact sound reduction ΔL_w .

Screed placed directly on the floor have no appreciable improvement of impact sound protection. A high insulation effect is achieved only by a combination with soft springy insulation layer (mass-spring-mass system) [Müller und Möser 2004]. Insulation starts above the resonance frequency f_0 of screed, which is calculated for very heavy raw floors according to Equation 4-8. This ideal connection is not valid for screed on wood floors as in this case the area-related mass of the "foundation" is often lower than the oscillating screed mass m'_1 . Thus, the resonance frequency is to be calculated according to Equation 4-9 allowing for foundation mass m'_2 .

$$\text{Equation 4-8: } f_0 = 160 \sqrt{\frac{s'}{m'_1}} \text{ Hz}$$

f_0 : resonance frequency [Hz]

s' : dynamic stiffness of the impact sound insulation [MN/m³]

m'_1 : area related mass [kg/m²]

$$\text{Equation 4-9: } f_0 = 160 \sqrt{s' \left(\frac{1}{m'_1} + \frac{1}{m'_2} \right)} \text{ Hz}$$

f_0 : resonance frequency [Hz]

s' : dynamic stiffness of the impact sound insulation [MN/m³]

m'_1 : area-related mass of screed [kg/m²]

m'_2 : area-related mass of raw ceiling [kg/m²]

Since the resonance frequency should be as low as possible, the dynamic stiffness of the impact sound insulation must be as low as possible, or the masses m'_1 and m'_2 as large as possible.

4.3.2.2 Discontinuities

When waves hit breaks in material or dimensions, part of the energy is reflected. This causes the energy passing by the break to be reduced compared with the incident energy [Cremer und Heckl 1995]. This insulation that is effective against the propagation of structure-borne sound can be increased by the use of elastic intermediate layers and barrier materials where barrier materials are used especially when the transfer of power must not be impaired by elastic layers. Two discontinuities are created which become effective only from a lower frequency limit.

4.3.2.3 Attenuation

On structure-borne sound absorbing subflooring, structure-borne sound energy is converted into heat as close to the source as possible. This is done by materials with high internal attenuation or friction on contact faces; it is characterized by the loss factor η .

Damping layers are represented mainly by ballasting used to increase the raw floor mass in common solid timber floor constructions, besides the impact sound absorbing subflooring of floating screed. Impact sound is emitted from the excited floating screed into the ballasting and converted there into heat. That is why loose chippings are used with timber floor constructions as lower impact sound levels are measured there due to their higher insulation compared with bonded ballasting. With wooden beam floors, insulation of bays is implemented by means of sound absorbing materials such as mineral wool. These should have at least a length-related flow resistance of $r \geq 5 \text{ kPas/m}^2$. Sound energy is also absorbed in screed where asphalt screeds and dry screeds have a higher internal attenuation than cement screeds. Thus, asphalt screeds show better impact sound absorbing subflooring for the same mass and impact sound absorbing subflooring slab. Cement screeds, however, can be used on softer impact sound absorbing subflooring slabs due to their higher rigidity, leading to better results [Holtz et al. 1999a].

4.3.2.4 Combination of insulation and attenuation

In practice, a combination of insulation and attenuation is most effective. Especially in the range resonance frequencies, increasing the loss factor results in a reduction in structure-borne sound. If there are no resonances in the excited frequency range, additional attenuation will not lead to any improvement as impact sound levels are determined only by mass or rigidity [Müller und Möser 2004]. This means in practice arrangement of elastic intermediate layers at a certain

distance from the source and additional attenuation in the form of a fill on an area where there is the highest energy density due to multiple reflections, between floating screed and raw floor.

4.4 Flanking transmission

Sound transmission between two rooms occurs through the separating component and via flanks. In case of a floor slab, indirect paths are mainly flanking walls, but there is also indirect sound transmission via airborne sound paths, such as cable ducts, see Figure 24. Direct sound transmissions are designated by D and d and flank sound transmission by F and f , where capital letters denote the sender side while lower-case letters denote the receiving side.

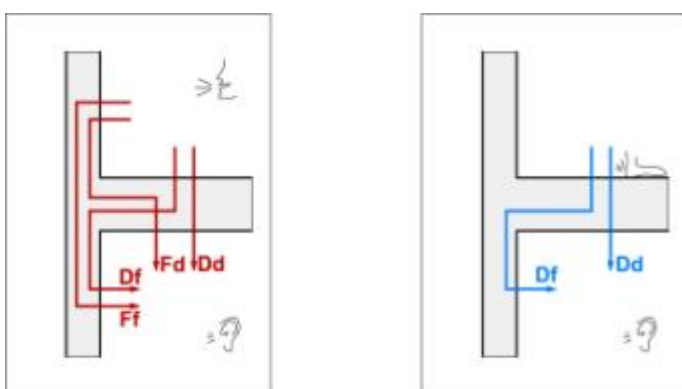

Figure 24: Airborne sound and impact sound transmission routes between neighboring rooms

It is not unusual here that flanking components emit sound levels that are equal to or greater than the separating component. As has turned out, sound insulation is low exclusively in buildings erected using solid timber components in comparison with timber frame constructions or mineral solid constructions, unless measures against flank sound transmission are taken [Östman et al. 2008]. In Section 7, building practice solutions for decoupling in solid timber constructions are shown.

Intense research activity in the field of sound vertical transmission during recent decades has resulted in a generally accepted calculation model according to [ÖNORM EN 12354-1] for the predetermination of sound insulation between rooms. However, this method of calculation is currently limited in its applicability for light-weight constructions (e.g. timber frame constructions or single-plank walls). Weber and Scholl [Weber und Scholl 2000] consider agreement between calculation model and measurement unsatisfactory based on their examination of the insulation of butt joints in light-weight walls made of metal support sections and gypsum plasterboards. In light-weight components, no diffuse impact sound fields occur due to high internal attenuation; thus, direct measurements of the insulation of butt joints are not always possible without restrictions. Thus, the calculation method according to [ÖNORM EN 12354-1] can be used with sufficient precision only for solid constructions; it is suitable for light-weight components with some reservations [Schoenwald et al. 2004]. As a result from the European COST action FP 0702, extensions for the acoustic prognosis of lightweight components according to [ÖNORM

EN 12354-1] were presented by Schoenwald, Mahn and Guigou-Carter at the Euronoise 2012 in Prague. Proposals that have not been integrated into European standardization.

4.5 Requirements

Requirements regarding sound insulation for external and separating components are regulated in the [OIB Guideline 5 2015] and [ÖNORM B 8115-2]. In [ÖNORM B 8115-5], voluntary sound insulation classes are additionally provided.

4.5.1 Requirements for external components

Requirements of external components have to be determined according to the site-related and component-related external noise level. Basically, a resulting weighted building sound insulation index $R'_{res,w}$ of at least 33 dB and a weighted sound insulation index R_w of opaque components of at least 43 dB has to be met. The weighted sound insulation index R_w of opaque external components has to be greater by at least 5 dB than the respectively required weighted resulting building sound reduction index $R'_{res,w}$ of external components.

The resulting sound reduction index is determined for the weakest component of the external surface which is usually the window. The impact of an average window cannot be compensated anymore. The window area proportion plays a significant role in this connection. Especially with facades exposed to high external noise loads, it is necessary to carefully examine the proportion of window areas and consider the floor plan.

Table 10: Requirements of the weighted resulting building sound insulation index $R'_{res,w}$ for residential buildings, residential establishments, hotels, schools, kindergartens, hospitals, spa buildings and the like according to [OIB Guideline 5 2015]

Relevant external noise level [dB]		Weighted resulting building sound insulation index $R'_{res,w}$ [dB]
Day	Night	
51-60	41-50	38
61-70	51-60	38.5 + 0.5 dB for every increase of the relevant external noise level by 1dB
71-80	61-70	44 + 1dB for every increase of the relevant external noise level by 1dB

For administration and office buildings, requirements are lower by 5 dB for the required weighted resulting building sound insulation index $R'_{res,w}$ than shown Table 10.

Floors and walls situated adjacent to thoroughfares and garages are required to have a weighted building sound insulation index R'_w of at least 60 dB. Building partition walls have to have a weighted building sound insulation index of at least 52 dB for every wall.

4.5.2 Requirements for internal components

Requirements for internal components are indicated in Table 11 and Table 12.

Table 11: Requirements for the weighted standard sound level difference $D_{nT,w}$ inside buildings according to [OIB Guideline 5 2015]

	$D_{nT,w}$ without connection by doors [dB]	$D_{nT,w}$ with connection by doors [dB]
Recreation rooms from rooms of different units and generally accessible areas	55	50
Hotel, class, hospital or residential rooms in homes from rooms of the same category	55	50
Hotel, class, hospital or residential rooms in homes from generally accessible areas	55	38
to adjoining rooms from rooms of different units and generally accessible areas	50	35
to hotel, class, hospital or residential rooms in homes from adjoining rooms	50	35

Table 12: Requirements for the weighted standard impact sound level $L'_{nt,w}$ in buildings according to OIB Guideline 5 [OIB Guideline 5 2015]

	$L'_{nt,w}$ to recreation rooms [dB]
rooms for other usage units (apartments, schools, kindergartens, hospitals, hotels, homes, administration and office buildings and comparable uses)	48
generally accessible terraces, roof gardens, balconies, loggias and attics	48
from generally accessible areas (e.g. staircases, pergolas)	50
from useful terraces, roof gardens, balconies, loggias and lofts	53

The weighted standard impact sound level to adjoining rooms can be increased by 5 dB.

5 Heat protection basics

5.1 General

Sound protection:

- Wood has the lowest thermal conductivity of all load-bearing building materials.
- Wood represents a low thermal bridge.
- The smaller wall thicknesses of the wooden outer walls enable a gain in usable space.

It is the objective of heat protection to keep energy consumption in a building for maintaining thermal comfort low as well as to protect internal surfaces of external components from mold growth and condensate.

5.2 Heat conductivity

Heat conductivity λ [W/(m.K)] is a material property indicating which amount of heat passes through a material of one meter thickness per m^2 at a temperature difference of one Kelvin. The higher this characteristic, the less suitable this material for heat insulation purposes is. Table 13 sums up the reference values of heat conductivity of select construction materials.

Table 13: Heat conductivity of selected construction materials, Sources: [ÖNORM EN 12524]¹⁾ and proposal [ÖNORM B 8110-7]²⁾

Material	Rated value of heat conductivity λ in W/(m.K)
Wood and cross-laminated timber Green density 500kg/m ³	0.13 ¹⁾
Concrete (reinforced with 1% steel) Green density 2300kg/m ³	2.3 ¹⁾
Mineral wool MW (SW)-W Green density 30kg/m ³	0.042 ²⁾
Mineral wool MW (GW)-W Green density 15kg/m ³	0.040 ²⁾
Expanded polystyrene foam (EPS-F) Green density 15.8kg/m ³	0.040 ²⁾
Wood fiber insulation material (WF-W) Green density 50kg/m ³	0.042 ²⁾
Wood wool (WW) Green density 350kg/m ³	0.11 ²⁾

A comparison of required thicknesses of various construction materials applied for achieving an area thermal resistance of 2m²K/W is shown in Figure 25.

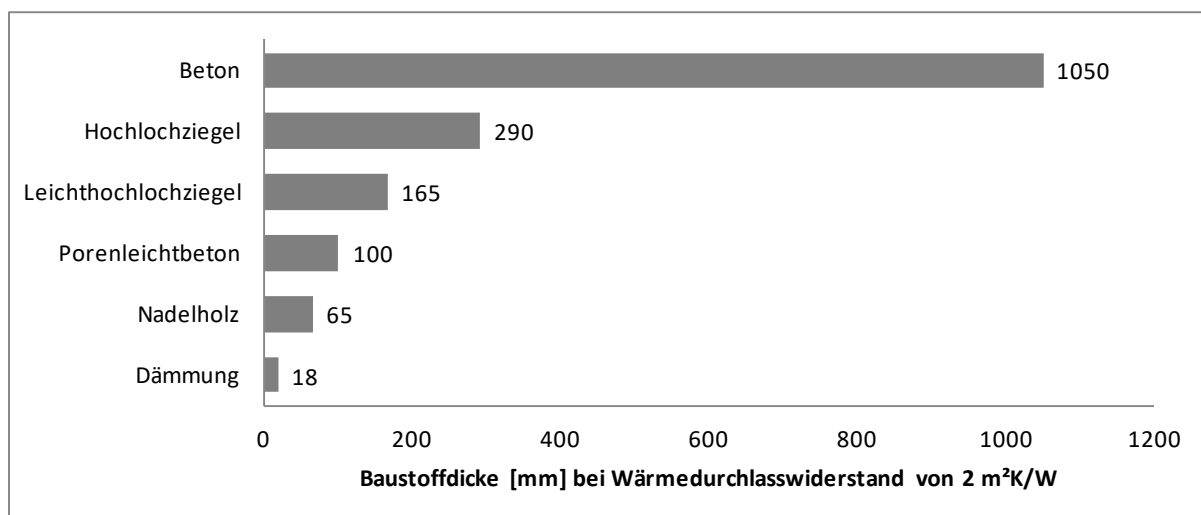

Figure 25: Comparison of required thicknesses of various construction materials for achieving an area thermal resistance of 2 m²K/W

5.3 U value

The U value, also designated thermal transition coefficient [$\text{W}/\text{m}^2\cdot\text{K}$], indicates which amount of heat passes through an object per m^2 and Kelvin temperature difference. It is calculated using the heat conductivities and the thicknesses of individual material layers and flat-rate values assigned to component boundaries. The higher the heat conductivity of the materials used, the higher the U value of a component. It is generally attempted to achieve a U value as low as possible.

The course of average U values for external walls of different constructions is shown in Figure 26. The heat insulation advantages of timber constructions are obvious. A statistic of IG Passivhaus proves that one half of the erected passive houses was realized in pure timber construction, see Figure 27. If mixed constructions are included whereas a rule the outer shell is put up also as a timber construction, then these have a market share of more than 60% of passive houses.

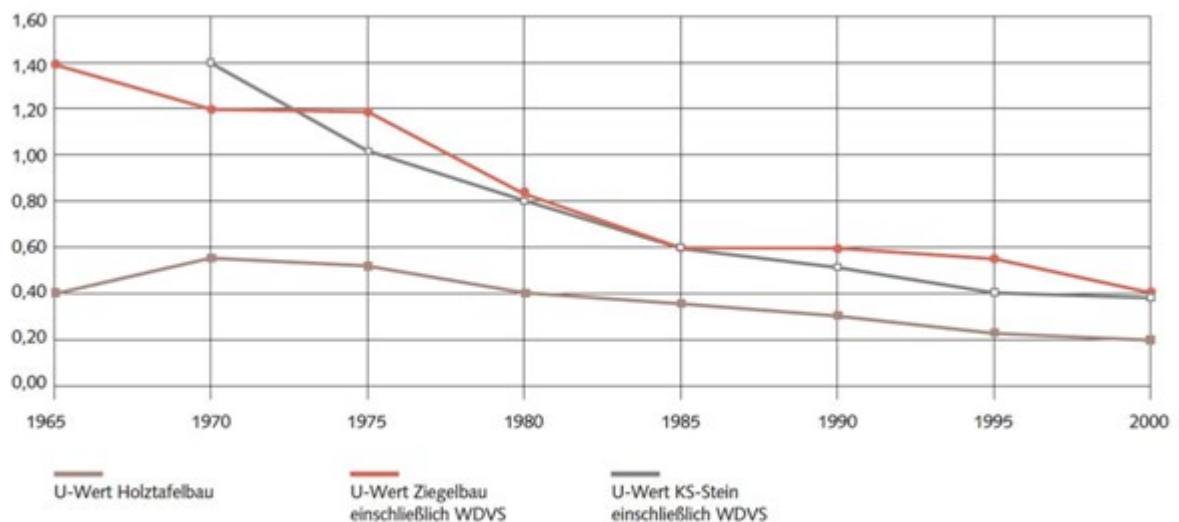

Figure 26: Development of heat protection of wood panel, single-leaf brick and sand-lime brick external walls, source: [Tichelmann 2007]

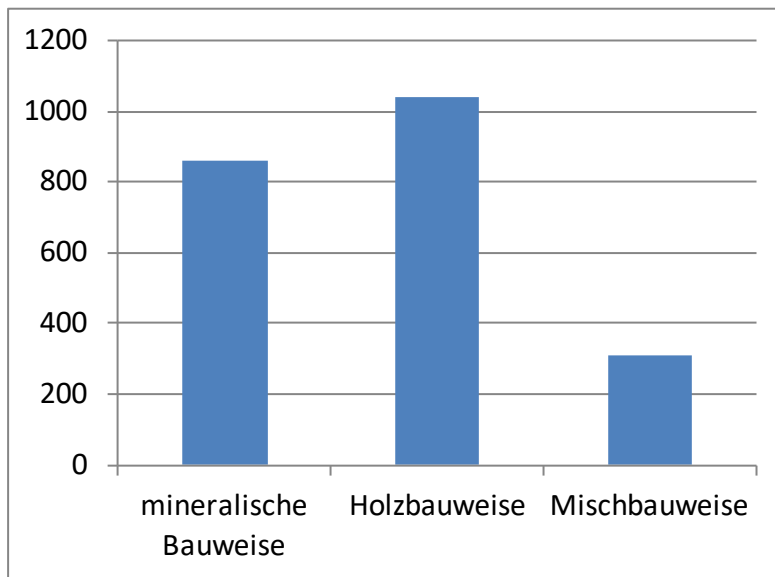

Figure 27: Passive house objects, classified according to their constructions, source: [Passivhaus]

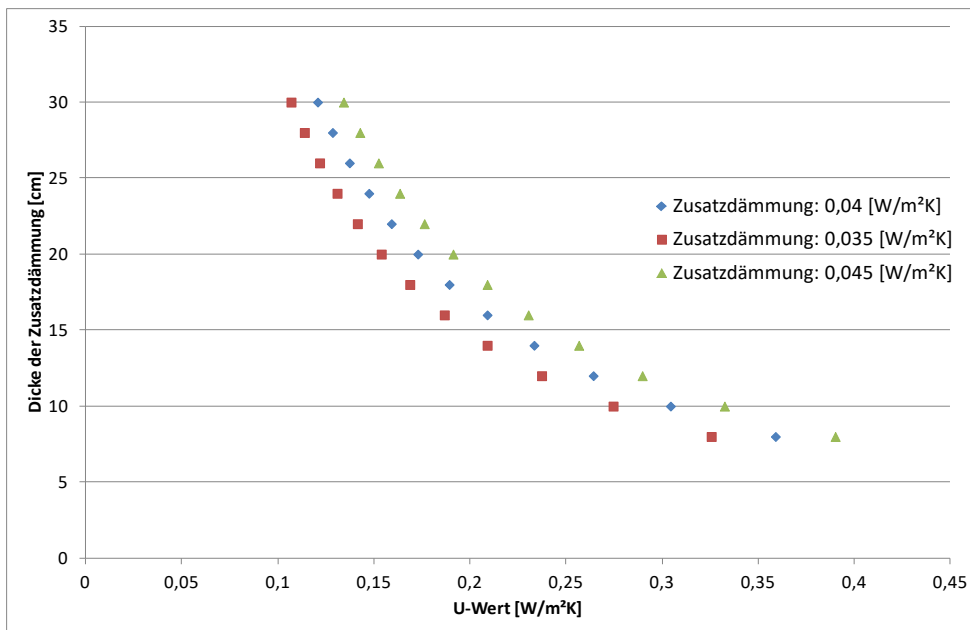

Figure 28: U values of a 8cm thick cross-laminated timber wall (λ : 0.13 W/m²K) as a function of thickness and heat conductivity of additional insulation

5.4 Summer suitability

Besides heat protection in winter, summer suitability of buildings is of great importance. Studies of Energy Efficiency of Room-Air-Conditioners (EERAC) [Adnot und Waide 2003; Varga und Pagliano 2006] forecast a quadruplication of the demand for cooling in Europe between 1990 and 2020.

To meet the summer suitability of rooms or buildings, energy input, ventilation and storage-effective mass of the construction need to be coordinated.

- Energy input

The energy input is composed of solar input, which depends on the dimensions, orientation and thermal characteristics of windows, their glazing as well as type and position of shading, and internal loads. On principle, sunshades have to be mounted on the outside.

- Air change

Air change by natural window ventilation depends on the size of the window opening, temperature difference, position of windows and wind flow. With a temperature difference of 4 K, air change rates of 4.6 h^{-1} can occur in case of cross ventilation between two stories, [Schnieders 2003].

Users play a significant role in achieving effective ventilation. Investigations in office buildings showed that windows are opened with high operative temperatures in rooms, but also with high outdoor temperatures, [Rijal]. Apart from this misbehavior in terms of building physics, aspects of safety and noise protection also play a role. Thus, it should be clarified during the planning process whether permanent ventilation at night is possible or acceptable, taking into consideration security requirements or needs for security and the L_{night} noise index. A Swedish study proved that with an L_{night} between 47 and 51 dB, one third of population does not open windows [Öhrström und Skanberg 2004].

Ventilation systems are usually designed for a hygienically healthy air change of $0.3 - 0.5 \text{ h}^{-1}$ in winter. Window ventilation can be supported with these air change rates. Pure summer ventilation using a ventilation system is not possible with economical use, even with ground heat exchangers. Furthermore, considerable sound emissions would result from such an increase in air exchange.

- Storage-effective mass

The third parameter is storage-effective mass. With regard to the interaction of three factors, the following generally holds:

The higher the storage capacity of the structure, the longer it takes to cool overnight. The lower the storage-effective mass, the more it is important to focus on reducing the energy input.

Holzforschung Austria investigates into the impact of different constructions on their behavior in summer in combination with shading and ventilation among other things at the building physics research house within the sub-project "Energy efficiency" of the COMET project HFA-TIMBER.

5.5 Requirements

Requirements to heat protection are regulated in the OIB Guideline 6. For new constructions of residential buildings, a maximum admissible yearly heating demand $HWB_{BGF, WG, max, RK}$ of $16 \cdot (1 + 3.0/l_c)$ in kWh/m² conditioned gross floor area in relation to geometry and related to the reference climate is required where the value must not exceed a maximum of 54.5 kWh/m²a for buildings having a gross floor area > 100m². Additionally, there are requirements to the final energy demand and the energy certificate has to additionally indicate the primary energy demand, overall energy efficiency factor and carbon dioxide emission.

Besides the requirements to heating demand or end energy demand, there are requirements to the thermal transition coefficient (U value) for new construction, renovation or renewal of components in conditioned rooms, see Table 14.

Table 14: Requirements to heat-transferring components, extract from OIB Guideline 6 [OIB Richtlinie 6 2015]

Component	U value [W/m ² K]
Walls bordering on outside air	0.35
Walls bordering on buildings at site boundaries	0.50
Floors and roof pitches individually bordering on outside air and attics (ventilated and non-insulated)	0.20
Floors bordering on unheated parts of building	0.40
Floors bordering on garages	0.30

With regard to air and wind tightness, guideline 6 requires that the air exchange rate at a differential pressure of 50 Pa (n_{50} value) be 3.0 h⁻¹ for buildings without a ventilation system and 1.5 for buildings with mechanically operated ventilation systems does not exceed h⁻¹. These values must be adhered to for residential buildings with a gross floor area of more than 400 m² for each residential unit.

6 Moisture-protection basics

6.1 General

Moisture protection:

- Wooden components are open to diffusion to the outside. An airtight layer with a higher s_d value is implemented on the inside.
- Energy-efficient construction requires a corresponding airtight building envelope, while still ensuring a sufficient air exchange rate. As a result of the convective entry, leaks can lead to a multiple of moisture entering the structure compared to diffusion.
- For this reason, great attention must be paid to the airtight design of the connections and penetrations
- If the constructive wood protection is correct, wooden components can be described as uncritical with regard to moisture protection.

The objective of moisture protection is to prevent moisture damage on and in components. In the following, some important characteristics and influential factors are briefly explained with regard to moisture protection.

6.1.1 Water vapor saturation pressure

For water to occur in gaseous form, the kinetic energy of its molecules needs to be greater than their mutual power of attraction. If this not the case, they attract one another and water cannot evaporate. With temperature rising, the kinetic energy of molecules increases and thus also the number of water molecules present in the room, provided there is a sufficient amount of liquid water to escape from. If the number of water molecules hitting the water surface equals the number of molecules hitting the water surface from the gas space and being retained there again, an equilibrium is attained. The gas space is then "water vapor saturated". The pressure these water molecules produce is denoted water vapor saturation pressure or saturated vapor pressure.

6.1.2 Water vapor partial pressure

Partial pressure denotes the pressure of a gas within a mixture composed of several gases. Adding up individual partial pressures of gases results in the overall pressure of the gas mixture.

Water vapor partial pressure p_v is thus the partial pressure of water vapor as part of the present overall pressure.

Outside the saturated vapor pressure p_{sat} occurs only in case of rain or fog. Under "normal" conditions, the actually present partial pressure of water vapor is less than the saturated vapor pressure.

6.1.3 Relative air humidity

The relative air humidity (RH) indicates the ratio between the actually present water vapor partial pressure and the saturated vapor pressure (cp. Figure 29).

Equation 6-1: $\varphi = \frac{p_v}{p_{sat}} \times 100$

- φ : relative humidity [%]
- p_v : water vapor partial pressure [Pa]
- p_{sat} : saturated vapor pressure [Pa]

6.1.4 Absolute humidity

Contrary to relative humidity, absolute humidity denotes the present, gaseous amount of water in a defined volume, thus water vapor concentration.

There is a linear relation between absolute humidity and water vapor partial pressure, see Figure 29. The figure shows that warmer air can hold a higher amount of water vapor. For example, air with 0°C / 100% relative humidity is heated to 20°C, this only has a relative humidity of 28%, see Table 15.

Table 15: Example for relative humidity

Temperature [°C]	Absolute humidity [g/m³]	Water content at saturation vapor pressure [g/m³]	Vapor pressure [Pa]	Saturation vapor pressure [Pa]	Relative humidity [%]
0	4,85	4,85	611	611	100
20	4,85	17,3	611	2340	28

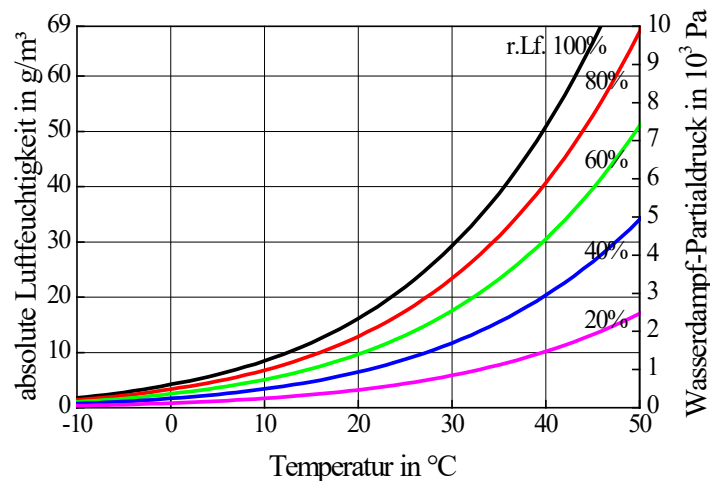

Figure 29: Dependence of absolute humidity and water vapor partial pressure on temperature and relative humidity

6.2 Diffusion

Diffusion is defined as the material transport in the molecular range due to the thermal proper motion of molecules through a different substance. The relevant driving potential for diffusion comes from concentration or partial pressure differences between which the material to be penetrated is present.

In case of considerations regarding heat and moisture in buildings, these are usually water vapor partial pressure differences.

6.2.1 Water vapor diffusion resistance

Water vapor diffusion resistance, also called μ value, indicates for the thickness of a layer of air in rest, by which factor it must be thicker compared to the thickness of a material to have the same diffusion resistance as the material.

6.2.2 Water vapor diffusion equivalent air layer thickness

Water vapor diffusion equivalent air layer thickness, also called s_d value, indicates how thick an air layer in rest should be to have the same diffusion resistance as the material proper. It can be calculated using the μ value as follows:

$$\text{Equation 6-2: } s_d = \mu \times d$$

s_d : Air layer thickness equivalent to water vapor diffusion [m]

μ : Water vapor diffusion resistance coefficient [-]

d : Material thickness [m]

According to a leaflet of the Purbond company, examinations on water vapor diffusion resistance of PUR adhesive films have shown that a film of 0.1mm corresponds to an s_d value of about 25mm spruce wood. According to examinations carried out at Holzforschung Austria, a typical

adhesive joint in dry climate (23°C and 26.5% average relative humidity) has the same diffusion equivalent air layer thickness as a spruce lamella with a thickness of 2-10mm, and in moist climate (23°C and 71.5% average relative humidity) that of a spruce lamella with a thickness of 7 - 19mm. The s_d value of cross-laminated timber elements depends on the thickness and pervasiveness of the adhesive film. Basically, an exchange of moisture can be ensured in a cross-laminated timber element. According to a leaflet of the Dynea company, the s_d value of a MUF joint can be equated with about 5mm spruce.

6.3 Convection

Apart from diffusion, there may additionally be convective moisture transport between a room inside and the outer area due to differences in air pressure. Convective moisture transport depends on leakages on the one hand and on pressure differences on the other hand. There may be pressure differences of several Pascal occurring in winter simply because of thermal, depending on the height of the continuous room inside, see Figure 30.

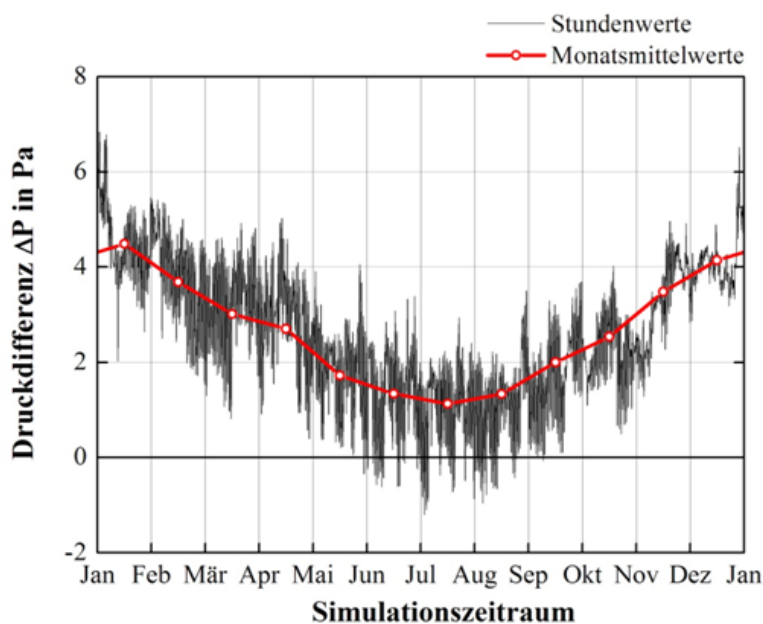

Figure 30: Pressure difference due to thermal in an 8m high room at the Klagenfurt site with an inside temperature of 24 ± 2 °C

In the upper part of the house, there is an excess pressure most time of the year, which leads to inside room air being pressed into components. For this reason, leakages in the upper part of the building are considered more crucial in terms of moisture protection.

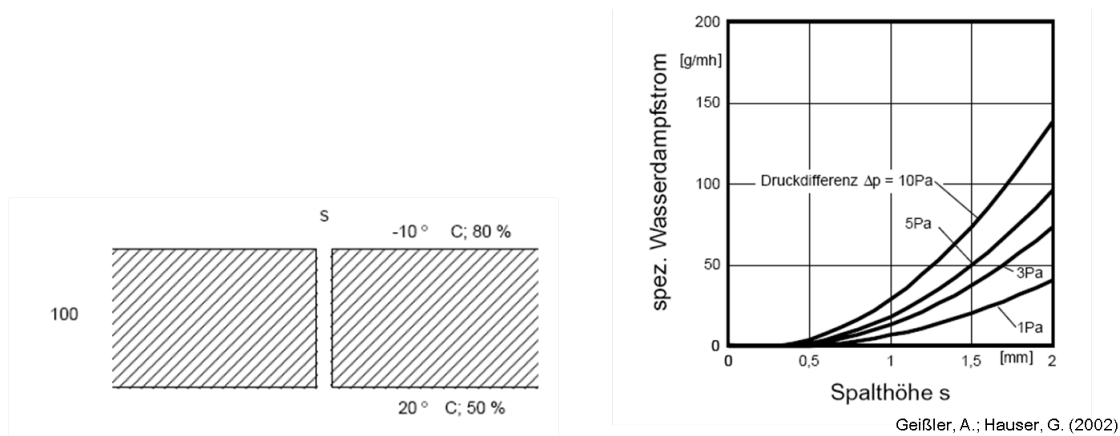

Figure 31: Specific water vapor flow in g/m·h as a function of gap height, source: [Hauser und Maas 1992]

Leakages can be basically divided with regard to their geometry into heat and moisture leakages where moisture leakages are considered more crucial in terms of moisture protection [Künzel Februar 2011].

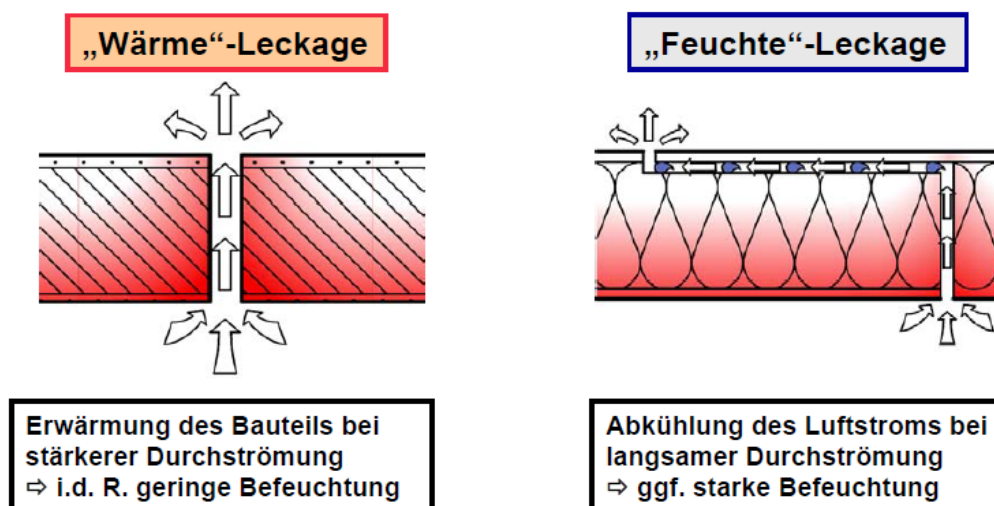

Figure 32: Heat and moisture leakages, source: [Künzel 2011]

The influx of moisture due to convection can be many times the input by diffusion. For this reason, air tightness is of great importance for the building shell [Nusser 2012].

6.4 Requirements

Requirements to moisture protection are regulated in [OIB Guideline 3 March 2015 and OIB Guideline 6 March 2015].

7 Common superstructures in cross-laminated timber constructions

7.1 External wall

External wall:

- Usually no vapor barrier or barrier is required.
- The airtightness of the cross laminated timber elements has been proven.
- In the case of the lowest energy or passive house construction, the use of a flow-tight membrane can still bring practical construction advantages.
- Inside exposed wood is possible.
- Fair-faced wood construction or direct cladding increase the storage-effective mass.
- They are insulating materials with a length-related flow resistance of $3 \text{ kPa}\cdot\text{s} / \text{m}^2 \leq r \leq 35 \text{ kPa}\cdot\text{s} / \text{m}^2$ to be used.
- Electrical installations can also be milled directly into the cross-laminated timber elements.
- A decoupled and insulated facing layer improves the sound insulation significantly

Basically, wood components are to be constructed permeable to the outside and with greater mass on the inside. The rules stated in this connection are valid for our climate zones and for buildings with conventional use; in case of cold storages, the partial pressure gradient is reversed and the vapor retarder is to be positioned on the outside. The requirements of Table 16 are applied to individual component layers:

Table 16: Survey of requirements to individual component layers

Component	Requirements
Interior cladding: GKF	Fire protection, sound protection, heat protection in summer
Insulated facing shell	sound protection, fire protection, air tightness of facing shell (retrofitting of electrical installations possible)
Cross-laminated timber element	bearing behavior, fire protection, air tightness of facing shell
Heat insulation	heat protection, fire protection (e.g. for floor-overlapping external wall strips), sound protection
Facade	weather protection, fire protection (fire propagation)

The airborne sound insulation index of the solid timber raw component highly depends on joint design, see Figure 33. By mounting heat insulation layers with facade claddings and dry linings or direct internal claddings, the impact of element joints can be neglected. In this way, wide distributions between individual solid timber elements can be greatly reduced by installing an internal dry lining and an insulation layer. [Holtz et al. 2002].

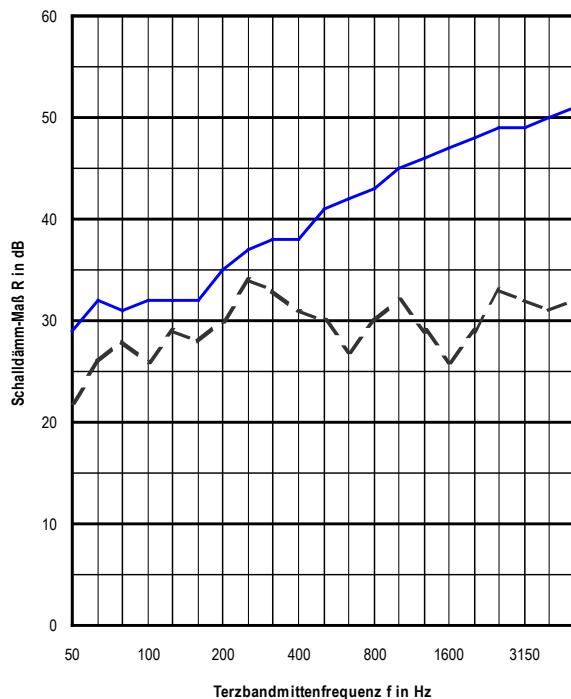
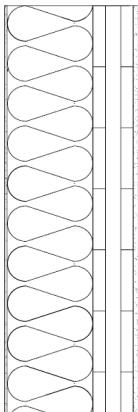
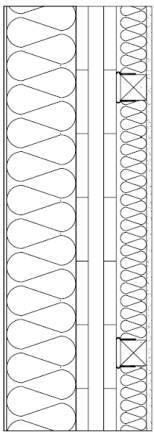

Figure 33: Impact of joint design on airborne sound insulation for a 160mm thick cross-laminated timber floor, butt joint open $R_w = 30$ dB; butt joint sealed $R_w = 45$ dB, source: [Holtz et al. 2002]

7.1.1 Examples

Table 17: External wall with external wall thermal insulation composite system (WDVS) with and without installation level (maximum component height 3 m)

Component	Thickness [mm]	Construction	Fire resistance $E_{d,fi}$	U value [W/m ² K]	R_w (C; C _{tr}) [dB]	$L_{nT,w}$ [dB]
 www.dataholz.eu awmopo01a-01	7.0 140.0 80.0 ¹⁾ 12.5	Plaster Stone wool MW-PT Cross-laminated timber GKF or GF	REI 60 35 kN/m	0.23	39 (-1;-4)	
 www.dataholz.eu wmopi01a-02	7.0 140.0 100.0 ²⁾ 60.0 60.0 12.5	Plaster Stone wool MW-PT Cross-laminated timber Battens on whip arm e=660 mm Mineral wool GKF or GF	REI 120 35 kN/m	0.18	49	

¹⁾: applies to a range between 78 and 85 mm

²⁾: applies to a range between 95 and 105 mm

Table 18: External wall with back-ventilated facade without and with dry lining (maximum component height 3 m)

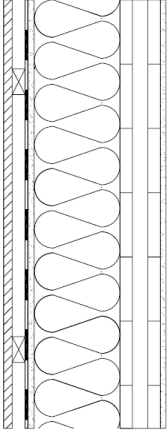
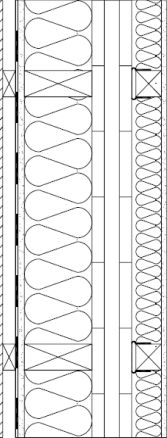
Component	Thickness [mm]	Construction	Fire resistance $E_{d,fi}$	U value [W/m ² K]	R_w (C; C _{tr}) [dB]	$L_{nT,w}$ [dB]
 www.dataholz.eu wmoho05a-01	20.0 30.0 15.0 200.0 100.0 ¹⁾ 12.5	Larch facade Battens Permeable film $s_d \geq 0.3$ m Gypsum fiberboard (GF) Mineral wool Cross-laminated timber GKF or GF	REI 60 35 kN/m	0.15	41	
 www.dataholz.eu wmohi02a-01	24.0 30.0 15.0 200.0 200.0 100.0 ¹⁾ 60.0 50.0 12.5	Larch facade Battens Permeable film $s_d \geq 0.3$ m Gypsum fiberboard (GF) Construction timber (6/20; e: 62.5 mm) Mineral wool Cross-laminated timber Battens resilient clips e = 660 mm Mineral wool GKF or GF	REI 90 35 kN/m	0.15	48	

¹⁾: applies to a range between 95 and 105 mm

7.1.2 Constructive rules

7.1.2.1 External wall thermal insulation composite system (WDVS)

Selection of insulation material of the WDVS exerts a significant influence on the sound insulation properties of the external wall. What is decisive is dynamic rigidity as well as raw density of insulating slabs and raw density and thickness of plaster. It can be assumed that WDVS made of polystyrene (EPS-F) and solid mineral main wall lead to a deterioration of sound insulation. This does not apply to systems composed of plasticized EPS-F as has been shown by laboratory measurements.

7.1.2.2 Insulation material

The selection of the insulation material in the shell or in the "bay" in case of external insulation with a ventilated facade can also have an effect on the sound insulation index. That is why installed insulation materials to be used as cavity attenuation material need to meet length-related flow resistance of $r \geq 5 \text{ kPa}\cdot\text{s}/\text{m}^2$. Based on studies by [Maack 2008], all of the fiber insulation materials having a length-related flow resistance of $3 \text{ kPa}\cdot\text{s}/\text{m}^2 \leq r \leq 35 \text{ kPa}\cdot\text{s}/\text{m}^2$ are regarded as equivalent in terms of building acoustics. These include besides mineral wool insulation materials, cellulose and wood fiber insulation materials also sheep wool and flax. With cellulose insulation materials having a length-related flow resistance of $r = 80 \text{ kPa}\cdot\text{s}/\text{m}^2$, the airborne sound insulation index is lower by 4 dB compared with mineral wool insulation according to measurements by [Maack 2008]. This insulation has an effect more like that of a closed shell and not that of cavity attenuation. If polystyrene is used, the deterioration is 9 dB. Polystyrene should not be used in bays for acoustic and fire protection reasons as well as processing (joint design) reasons.

7.1.2.3 Internal cladding / dry lining

Another essential influence comes from the execution of the dry lining. As a rough approximation, the improvements shown in Table 19 occur between direct cladding using gypsum plasterboards, a shell mounted directly and a shell mounted on a whip arm. Gypsum boards can be designated flexible shells when they have thicknesses of 15 mm maximum. Instead of using thicker boards, it is preferable to use them in multiple layers.

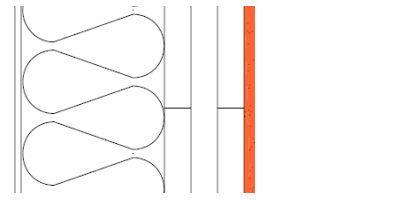
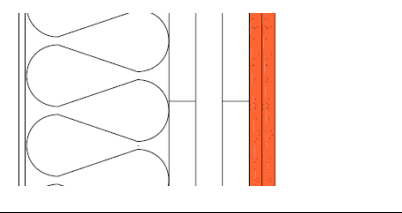
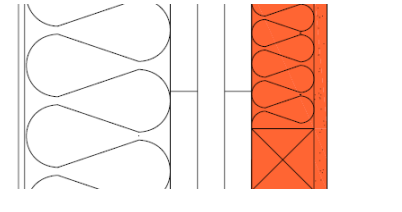
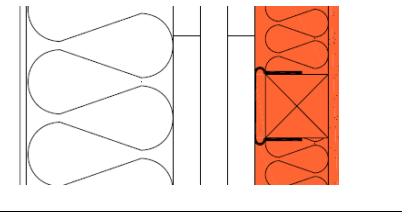
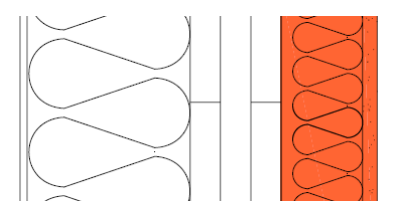
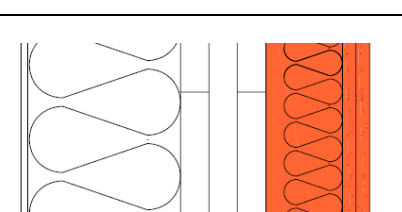

Table 19: Reference values for the improvement of the airborne sound insulation index of a non-clad cross-laminated timber external wall with a WDVS

	Construction of internal cladding	Improvement
	one-layer cladding with 12.5 mm gypsum plasterboards	0 - 1 dB
	double-layer cladding with 12.5 mm gypsum plasterboards	1 - 2 dB
	facing shell insulated with mineral wool, mounted directly on the raw wall and clad with 1 x 12.5 mm gypsum plasterboard	< 6 dB
	facing shell insulated with mineral wool, mounted with battens on resilient clips and clad with 1 x 12.5 mm gypsum plasterboard	< 15 dB
	facing shell insulated with mineral wool, completely decoupled ¹⁾ : with 85 mm cavity with cavity attenuation \geq 50 mm mineral wool between CW profile and clad with 1 x 12.5 mm gypsum plasterboard	< 22 dB
	facing shell insulated with mineral wool, completely decoupled ¹⁾ : with 85 mm cavity with cavity attenuation \geq 50 mm mineral wool between CW profile and clad with 2 x 12.5 mm gypsum plasterboard	< 23 dB

¹⁾ Installation only on the floor and on the floor

7.2 Load-bearing internal wall

Table 20: Internal wall with and without gypsum plasterboard (maximum component height 3 m)

Component	Thickness [mm]	Construction	Fire resistance $E_{d,fi}$	U value [W/m ² K]	R_w (C; C _{tr}) [dB]	$L_{nT,w}$ [dB]
 www.dataholz.eu iwmxxo01a-00	12.5 100.0 ¹⁾ 12.5	GKF or GF Cross-laminated timber GKF or GF	REI 60 ²⁾ 35 kN/m		38 (-2;-5)	
 www.dataholz.eu iwmxxo01a-01	100.0 ¹⁾	Cross-laminated timber	REI 60 35 kN/m		33 (-1;-4)	

¹⁾: applies to a range between 95 and 105 mm

²⁾: The R 60 design requires double cladding (2 x 12.5 mm) GKF or GF.

7.3 Partition wall

Partition wall:

- Single-leaf partition walls require completely decoupled shells.
- Space ($\geq 5\text{cm}$) in double-leaf partition walls needs to be completely filled up with mineral wool for sound insulation.
- It is to be ensured that joints, connections and installations are carried out in an airtight way.
- For sound protection reasons, it is not recommended to install and lead water pipes as well as sanitary and heating pipes through.

Basically, partition walls can be built with one or two leaves. For a single-leaf partition wall, shells that are freestanding on both sides are required at any rate. If the floor is constructed as a continuous floor, then it also requires a suspension. Just like for external walls, there may be differences as follows that are due to shell design. The rules stated apply both for walls between units and for general development zones.

7.3.1 Examples

Table 21: Partition wall, single leaf (maximum component height 3 m)

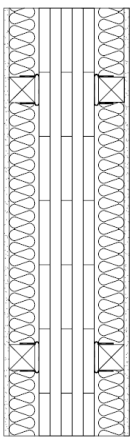
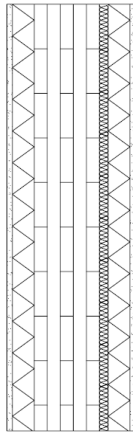
Component	Thickness [mm]	Construction	Fire resistance $E_{d,fi}$	U value [W/m ² K]	R_w (C; C _{tr}) [dB]	$L_{nT,w}$ [dB]
 www.dataholz.eu twmxxo04a-00	12.5 60.0 60.0 100 ¹⁾ 60.0 60.0 12.5	GKF or GF Mineral wool Battens on resilient clips e = 660 mm Cross-laminated timber Battens resilient clips e = 660 mm Mineral wool GKF or GF	REI 90 35 kN/m	0.25	57	
 www.dataholz.eu twmxxo01-00	15.0 50.0 140 ²⁾ 20.0 50.0 15.0	Lime-gypsum plaster Heraklith BM Cross-laminated timber Heralan TP Heraklith BM Lime-gypsum plaster	REI 90 35 kN/m	0,33	60 (-3;-9)	

¹⁾: applies to a range between 95 and 105mm

²⁾: applies to a range between 134 and 145mm

Table 22: Partition wall, double leaf (maximum component height 3 m)

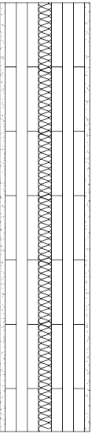
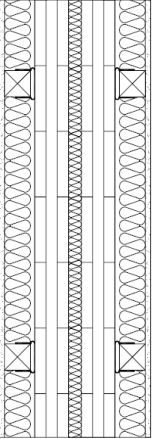
Component	Thickness [mm]	Construction	Fire resistance $E_{d,fi}$	U value [W/m ² K]	R_w (C; C _{tr}) [dB]	$L_{nT,w}$ [dB]
 www.dataholz.eu wmxxo03a-00	12.5 80.0 ¹⁾ 30.0 80.0 ¹⁾ 12.5	GKF or GF Cross-laminated timber Impact sound insulation MW-T Cross-laminated timber GKF or GF	REI 60 35 kN/m	0.38	56	
 www.dataholz.eu wmxxo06a-00	12.5 50.0 50.0 80.0 ¹⁾ 30.0 80.0 ¹⁾ 50.0 50.0 50.0 12.5	GKF or GF Battens resilient clips e = 625 mm Mineral wool Cross-laminated timber Impact sound insulation MW-T Cross-laminated timber Battens resilient clips e = 625 mm Mineral wool GKF or GF	REI 60 35 kN/m	0.21	61	

¹⁾: applies to a range between 78 and 85 mm

7.3.2 Constructive rules

7.3.2.1 Improvement of sound insulation index by means of shells

Table 23: Reference values for improving the sound insulation index for an unclad double-leaf cross-laminated timber wall with insulated space (60 mm mineral wool)

	Construction of internal cladding	Improvement
	single-sided cladding with 1 x 12.5 mm gypsum plasterboards	1 dB
	double-sided cladding with 1 x 12.5 mm gypsum plasterboards	2 dB
	single-sided insulated facing shell on resilient clips	< 7 dB
	double-sided insulated facing shell on resilient clips	< 10 dB
	single-sided facing shell, completely decoupled ¹⁾ with 85 mm cavity with cavity attenuation 50mm mineral wool between CW profile and clad with 2 layers of gypsum plasterboards	< 11 dB
	double-sided shell, completely decoupled ¹⁾ with 85 mm cavity with cavity attenuation 50 mm mineral wool between CW profile and clad with 2 layers of gypsum plasterboards	< 15 dB

¹⁾: Installation only on the floor and on the floor

7.3.2.2 Space between double-leaf partition walls

The greater the distance between partition walls, the higher is the sound reduction index; an effective minimum distance of 5 cm is recommended. At any rate, the space has to be insulated by means of stone wool. Asymmetric structures can improve the sound reduction index.

Spaces in double-leaf partition walls need to be completely filled with insulation material. A continuous air layer is inadmissible from reasons of fire and sound protection (because of a potential connection).



Figure 34: Space of the partition wall filled up with mineral wool (gypsum plasterboard for sound protection reasons)



Figure 35: Stone wool and inadmissible continuous air layer between partition walls

7.4 Fire compartment forming wall

Fire compartment forming wall:

- Space ($\geq 5\text{cm}$) in double-leaf setups needs to be completely filled up with mineral wool
- On the boundary, non-combustible claddings and coverings are to be used.
- Electric installations require to be laid in shells or compensation measures.
- It is to be ensured that joints, connections and installations are carried out in an airtight way
- For sound protection reasons, it is not recommended to install and lead water pipes as well as sanitary and heating pipes through.

7.4.1 Example

Table 24: Example of a fire compartment forming wall (maximum component height 3 m)

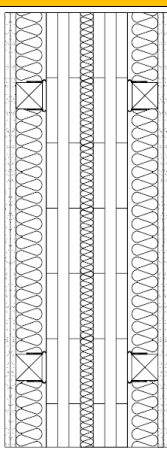
Component	Thickness [mm]	Construction	Fire resistance $E_{d,fi}$	U value [W/m ² K]	$R_w (C; C_{tr})$ [dB]	$L_{nT,w}$ [dB]
 www.dataholz.eu wmxxo06a-00	2x12.5 60.0 50.0 80.0 ¹⁾ 30.0 80.0 ¹⁾ 60.0 50.0 2x12.5	GKF or GF Battens on resilient clips $e=625\text{ mm}$ Mineral wool Cross-laminated timber Impact sound insulation MW-T Cross-laminated timber Battens on resilient clips $e=625\text{ mm}$ Mineral wool GKF or GF	REI 90 35 kN/m	0.20	61	

¹⁾: applies to a range between 78 and 85 mm

7.4.2 Construction rules

In addition to hints on partition walls, the following construction principles hold for walls forming fire compartments in timber constructions:

- Space between double-leaf components needs to be completely filled up with insulation materials at least of class A2.
- Penetrations through walls forming fire compartments should be avoided in principle. If this is not realizable, penetrations need to be partitioned off with certified systems.
- For walls forming fire compartments at the plot boundary, non-combustible coverings or claddings are recommended if add-ons to a building are possible or admissible. This measure is recommended, which is a deviation from the requirements of OIB Guideline 2 for all constructions.
- Electric installations have to be kept in insulated installation ducts or prewall installations with walls forming fire compartments. In case of laying cables in load-bearing solid timber components, compensation measures are required, such as encapsulation of cavity sockets with non-combustible slabs or use of tested fire protection sockets. It is advised against using a plaster bed of at least 25 mm thickness as a compensation measure for building practice reasons.

7.5 Elevator walls

Elevator shafts can also be put up as a timber construction for buildings of building class 4 but requires the installation of a non-combustible cladding on the inside. For reasons of sound protection, it is recommended to build shafts as double leaves; this should be done generally with elevators without a machine room. Details of execution, also with regard to the impact sound insulation for the bearing of the engine bracket, can be taken from [Bundesverband der Gipsindustrie e.V. Industriegruppe Gipsplatten 2004].

7.6 Separating floor

Separating floor:

- A mineral wool impact sound insulation having a dynamic rigidity as low as possible ($s' \leq 10 \text{ MN/m}^3$) shall be used. Dry screeds require a higher dynamic rigidity ($s' \geq 20 \text{ MN/m}^3$).
- Ballasting shall be installed with gross densities $\rho \geq 1.300 \text{ kg/m}^3$ in unbonded state:
- Polystyrene ballasting are unsuitable as a measure for improving impact sound insulation in timber constructions.
- Cross-laminated timber floors with decorative bottom view need an improved floor construction (at least 10cm unbonded ballasting).
- For cross-laminated timber floors with wood bottom view, attention needs to be paid to airtightness in the area of electric installations.
- Suspended bottom view constructions have to be decoupled and void space filled up with fibrous insulating materials.
- Spring strips excel by better sound protection than spring clips.
- Instead of a thick gypsum board (e.g. 18 or 25mm), two less thick boards shall be used for sound protection reasons.
- In case of floating floor screed, a coupling between screed and raw floor needs to be prevented by means of a continuous separating film. In the area of pipe intersections, couplings have to be prevented.
- Sound bridges towards the screed in the vicinity of walls, supports, installations and the like need to be avoided by edge insulation strips.

Separating floors can be executed with decorative timber quality and with suspension. Decorative timber floors or directly clad floors without any sound insulating suspensions require an improved floor structure to meet the requirements for impact sound protection.

7.6.1 Example

Table 25: Example of a separating floor (maximum span 5 m)

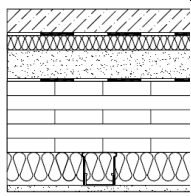
Component	Thickness [mm]	Construction	Fire resistance $E_{d,fi}$	U value [W/m ² K]	$R_w (C; C_{tr})$ [dB]	$L_{nT,w}$ [dB]
 www.dataholz.eu dmnxa04a-01	60.0	Cement screed	REI 60 5 kN/m ²	0.25	53	56
		Separating layer plastic material				
	30.0	Impact sound insulation MW-T				
	60.0	Ballasting bonded				
		Trickle protection				
	140.0 ¹⁾	Cross-laminated timber				
	70.0	Suspension e = 410mm				
60.0	mineral wool					
12.5	GKF or GF					

¹⁾: applies to a range between 134 and 145 mm

7.6.2 Constructive rules

7.6.2.1 Floor surfacing

Carpets usually result in high impact sound level reduction. According to [ÖNORM B 8115-2], carpets, wall-to-wall carpets, mats and the like must not be included. Any floor surfacing that is applied to floors in a permanent way, such as screeds, glued-on parquet and ceramic tiling, is to be included. For hotels, homes and balconies, requirements may be met by permanent floor surfacing, such as fitted carpets, glued-on textile flooring, plastic bottom and linoleum.

7.6.2.2 Screeds

In multi-story timber constructions, cement screeds on impact sound insulation slabs are usually used. They are characterized by good improvement of impact sound and economic efficiency. Sound protection can be improved in the low frequency range by increasing thickness from 50mm to a maximum of 80mm. One disadvantage of wet screed is the moisture introduced, which is to be considered in construction scheduling and poses no problem in building practice.

Alternatively, dry screed can be applied to impact sound insulation slabs, which however have only a low improvement of impact sound on timber floors. Apart from lacking construction moisture, low construction heights are an advantage.

For dry screed systems or double-floor systems, frequently the weighted impact sound reduction ΔL_w is stated. As a rule, the characteristics stated refer to tests on mineral floors. Results cannot be directly transferred to timber constructions. Lang has published in [Lang] weighted impact

sound reductions $\Delta L_{t,w}$ (timber beam floor) and $\Delta L_{tv,w}$ (solid timber floor) of 14 different floor constructions.

Screed is to be installed on a floating basis, that means that screed rests on an impact sound insulation slab and has no direct contact with walls, supports, installed cables and pipes or door openings or frames. Defective detail processing with such connections can deteriorate impact sound protection by up to 20 dB (!). Flanking sound paths can also be formed by plinths or installations of showers and bathtubs.

7.6.2.3 Impact sound insulation

Installed impact sound insulation needs to have a dynamic rigidity s' as low as possible. In case of wet screeds, products having $s' \leq 10 \text{ MN/m}^3$ can be used. Laboratory measurements showed that the weighted standard impact sound level $L_{n,w}$ can be improved from 53 dB to 46 dB by the application of an impact sound insulation with a dynamic rigidity of 10 MN/m^3 instead of 35 MN/m^3 . Examinations of solid timber floor constructions without a suspended floor lead to a weighted standard impact sound level of 44 dB for use of a 35/30 mm mineral wool impact sound insulation with a dynamic rigidity $s' \leq 5 \text{ MN/m}^3$ compared with 56 dB of a 21/20 mm thick impact sound insulation with a dynamic rigidity s' of 24 MN/m^3 , [Holtz et al. 2004].

Impact sound insulations made of mineral wool have a considerably lower dynamic rigidity than those made of polystyrene materials and are therefore preferable in timber constructions. According to Köhnke, impact sound levels are improved by 3 – 4 dB if mineral wool is used instead of polystyrene [Köhnke 2012].

For dry screeds, impact sound insulation with higher dynamic rigidity (from about 20 MN/m^3) is basically required.

7.6.2.4 Bulk material

Bulk material is used as an additional mass, in case of a granular bed also for attenuation. For that reason, non-bonded granular material having a minimum density of $1,300 \text{ kg/m}^3$ and a minimum thickness of 5 cm is to be used. With floors without a suspension, thickness needs to be increased to at least 10 cm. In the past, there used to be discussions with screed installers with regard to the processability of granular materials for various objects. Granular materials can also be suspended in water to achieve their pumpability. If the construction schedule is considered, no problems arise as can be seen from realized objects. These objects can also be regarded as a verification of suitability for the use of non-bonded granular materials. If rigid bonded granular materials are used instead of non-bonded materials, the weighted standard impact sound insulation $L_{n,w}$ is deteriorated by 3 – 6 dB depending on the construction.

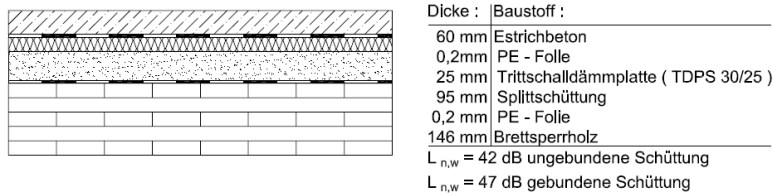

Figure 36: Impact of non-bonded granular material on weighted standard impact sound insulation $L_{n,w}$, source: [Ferk 2006]

7.6.2.5 Laying of electric cables

In case of visible cross-laminated timber floors, attention is to be paid to airtightness within individual apartments where electric pipework is laid for floor lamps. This pipework is laid on the raw floor top as a rule. It should be remembered that penetrations through the floor must be executed in an airtight way and pipework is laid such that individual cables can be subsequently pulled in.



Figure 37: Laying of electric cables is to be executed in an airtight way for visible cross-laminated timber floors

7.6.2.6 Suspended floor

As cladding for suspended floors, usually gypsum boards or gypsum fiberboards are used in timber constructions. A suspended floor directly mounted on a timbered floor using battens can result in an improvement of up to 15 dB. By using a spring strip, the improvement increases up to 25 dB for a timber beam floor, while it is 4 dB for solid timber floor due to the low distance between raw floor and suspended floor [Holtz et al. 1999b]. The cause of this minor value in case of solid timber constructions is the lower shell distance. Therefore, a decoupled mounting using spring strip or whip arm is recommended. However, mounting is crucial, see Figure 33. A rigid connection deteriorates sound protection of this measure. Various investigations into timber frame floors have shown that the use of spring strips instead of whip arms leads to much better impact sound properties of floors [Polleres und Schober 2004], [Lang 2004].

Double flexible claddings (e.g. 2 x 12.5 mm) are necessarily more advantageous than a thicker fiberboard (e.g. 25 mm). Thicker gypsum boards lead to worse results, despite their higher mass. As a rule, suspensions are hung about 6 cm lower and provide improvements in the medium frequency range. Achieving significant improvements also in the lower frequency range by

suspension would require suspension heights of ca. 20 cm and an additional increase in the vibrating mass (additional gypsum board).

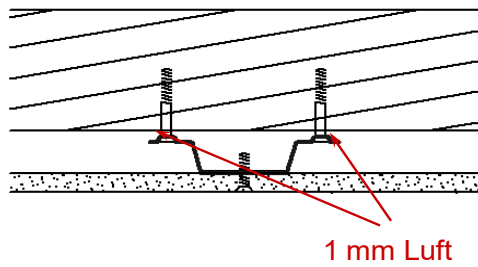

Figure 38: Schematic represented of the mounting of a decoupled suspension, source: [Holtz et al. 1999b]



Figure 39: Mounting with decoupled suspension of whip arm, source: Knauf company



Figure 40: left: whip arm with elastic decoupling, right: spring strip



Figure 41: Floor system with whip arm and GKF with good sound protection properties, source: Knauf company

7.6.3 Constructive recommendation

7.6.3.1 Continuous floor without suspension

In case of continuous floors, a suspension is always required for decoupling different units.

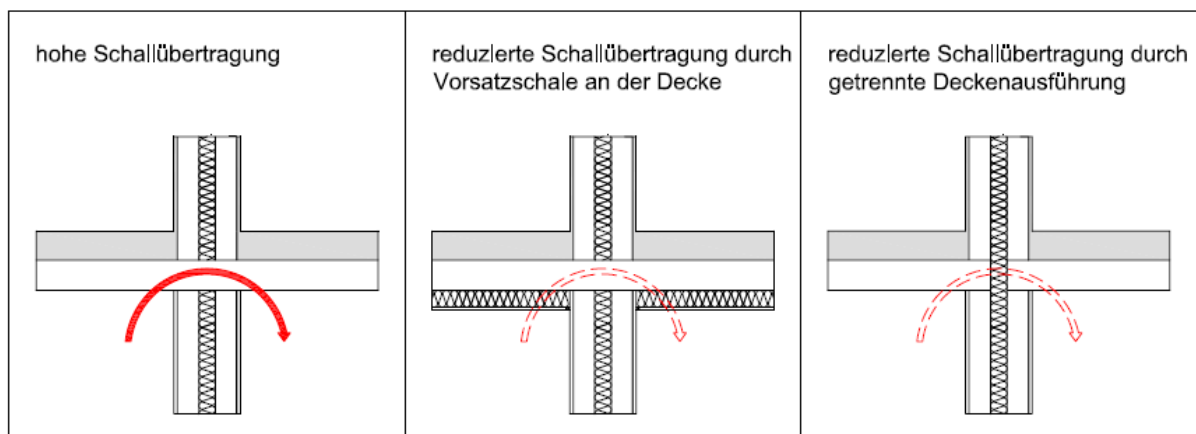

Figure 42: Sound transmission with continuous floors



Figure 43: Continuous floors, if used with partition walls, need a suspension in order to prevent sound longitudinal conduction

7.6.3.2 Continuous screen film

A connection between screed and raw floor has to be prevented, thus the screed film must not be faulty at any rate. A direct connection between screed and raw floor can result in a deterioration of impact sound insulation of up to 15 dB, [Köhnke 2012].

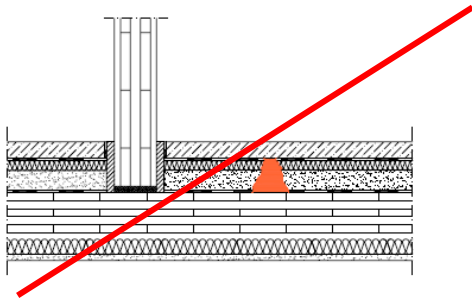

Figure 44: Faulty installation of screed film created a direct connection between screed and raw floor

7.6.3.3 Avoidance of sound bridges caused by crossing

Based on the contact between screed and raw floor due to pipelines or their intersection points, impact sound insulation may deteriorate by up to 4 dB, [Köhnke 2012].

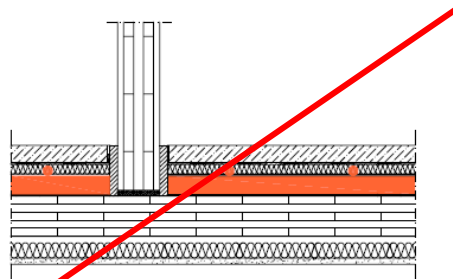

Figure 45: Incorrect execution: intersection of pipelines

7.6.3.4 Use of mineral wool having a dynamic rigidity as low as possible as impact sound insulation

According to Köhnke, impact sound levels are improved by 4 dB if mineral wool is used instead of polystyrene [Köhnke 2012].

7.7 Flat roof

Flat roof:

- The vapor retarder on top of cross-laminated timber elements can be used as a temporary weather protection, which requires a proof of suitability.
- In buildings of building class (GK) 4, non-combustible insulation materials (such as stone wool) shall be used.
- Tapered insulation of class E is admissible, provided the predominant portion of insulation comprises stone wool.
- In buildings of GK 4, complete insulation of class E may be used if a top concrete layer of least 5 cm or layers of other materials with equivalent fire protection properties are applied on the raw timber floor.
- Cross-laminated timber floors with a decorative wood bottom view require airtightness of electric installations and laying to be considered.

7.7.1 Examples

Table 26: Examples of flat roofs, without and with suspended bottom view for a span of 5 m

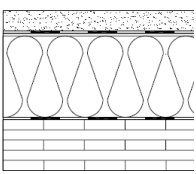
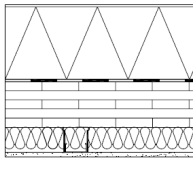
Component	Thickness [mm]	Construction	Fire resistance $E_{d,fi}$	U value [W/m ² K]	R_w (C; C _{tr}) [dB]	$L_{nT,w}$ [dB]
 www.dataholz.eu dmnko01	50.0	ballasting, gravel separating fleece $s_d \geq 0,2$ m	REI 60 5 kN/m ²	0.16	40 (0;-3)	
	200.0	sealing sheet $s_d \geq 100$ m stone wool MW-PT				
	125.0	sealing sheet $s_d \geq 500$ m Cross-laminated timber				
 www.dataholz.eu dmbi01a	200.0	sealing sheet $s_d \geq 100$ m polystyrene EPS	REI 60 5 kN/m ²	0.13	48 (-3;-9)	
	125.0	sealing sheet $s_d \geq 500$ m Cross-laminated timber				
	70.0	Suspension $e = 415$ mm				
	60.0	mineral wool				
	12.5	GKF or GF				

7.7.2 Construction rules

7.7.2.1 On-roof insulation systems

Flat roofs with a cross-laminated timber construction have a construction physical advantage in that there is a clear separation between supporting structure and insulation. This entails the statically effective component not being in the area endangered by condensation water. Special attention needs to be paid to selecting insulation material. For walkable roofs, a maximum compression of 10% is admissible. Appropriate insulation materials for over-rafter insulation systems are listed in Table 27. Walkable flat roofs require insulation materials that are resistant to compression. Besides EPS, XPS, PUR and foam glass, bonded mineral wool MW-WD can be used.

Table 27: Heat insulation materials for over-rafter insulation [Reyer et al. 2002]

Insulation material		Characteristics			
		$\rho^{1)}$ in kg/m ³	μ [-] ²⁾	λ in W/(m.K)	c in J/(kg.K)
mineral wool		glass wool: 20 - 150 stone wool: 25 - 220	1 - 2	0.035 - 0.050	840
EPS	PS 15	15	20/50	0.035	1500
	PS 20	20	30/70	0.035	
	PS 30	30	50/100	0.04	
XPS ³⁾		20 - 50	80/250	0.030 - 0.040	1500
PUR		30 - 80	30/100	0.025 - 0.040 with hydrochlorofluorocarbon: 0.020	1400
foam glass		105 - 165	$\rightarrow \infty$	0.040 - 0.055	840

1): In case of low gross densities, a supporting structure is required.

2): For structural design, the more unfavorable value shall be used.

3): To be installed with a separating layer below the sealing [Adriaans 2004]

For sound protection reasons, stone wool insulation is to be preferred over polystyrene insulation. A combination with tapered insulation boards made of polystyrene is basically possible. According to Table 1a of OIB Guideline 2, insulation materials having a reaction-to-fire performance of at least B shall be used for timber roof constructions in objects of building class 4. If the predominant portion of insulation is non-combustible, insulation materials of class E may be used as sloping boards.

7.7.3 Constructive recommendations

7.7.3.1 Vapor retarder as temporary weather protection

The vapor retarder on top of cross-laminated timber elements simultaneously serves as a short-term weather protection during the construction phase.



Figure 46: Vapor retarder (bituminous sealing) on a flat roof as a required weather protection

8 Connection details

8.1 Base part

8.1.1 General

The base part is a critical detail for timber constructions in terms of moisture protection. Therefore, the timber construction shall be put up on a mineral base and should have a base height of 30 cm, see Figure 47. If special building construction measures are taken, this height may be reduced. Appropriate measures are for instance drainages, metal sheet covering and roof overhang, see Figure 48 and Figure 49. At any rate, a minimum value of 10 cm of threshold against the ground and 5 cm against water-leading planes, such as terrace sealings, shall be met according to [ÖNORM B 2320].

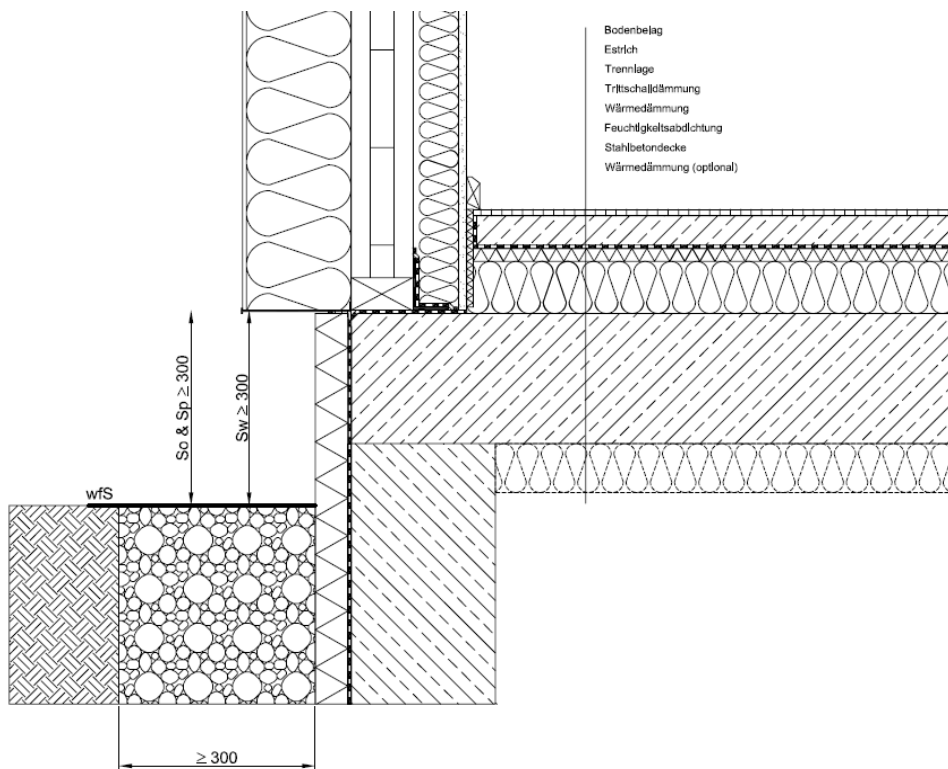

Figure 47: Standard base detail

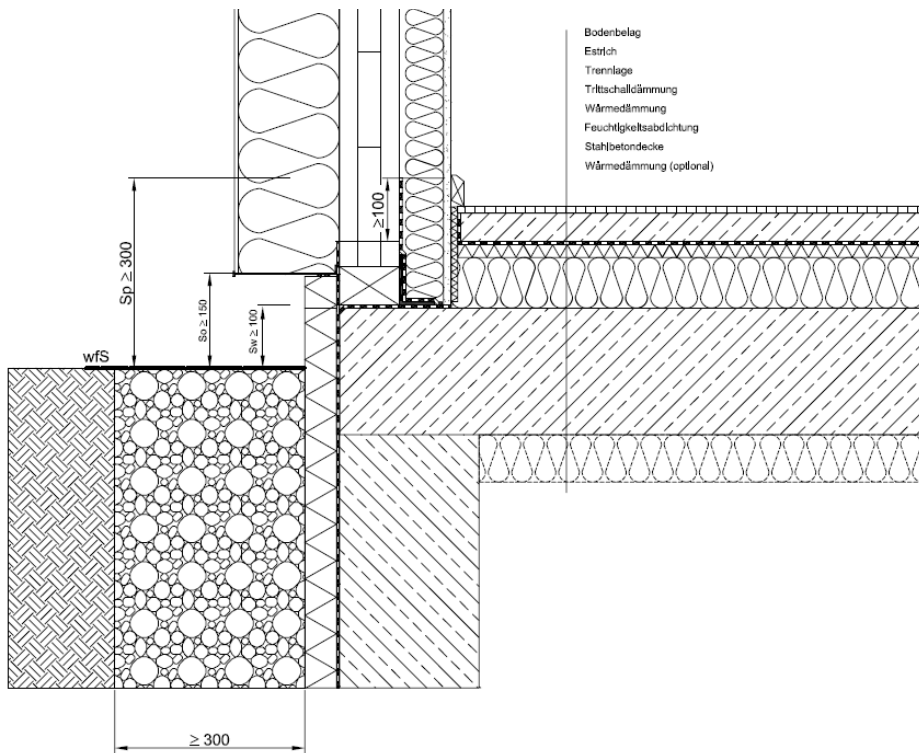

Figure 48: Base detail with minimum heights:

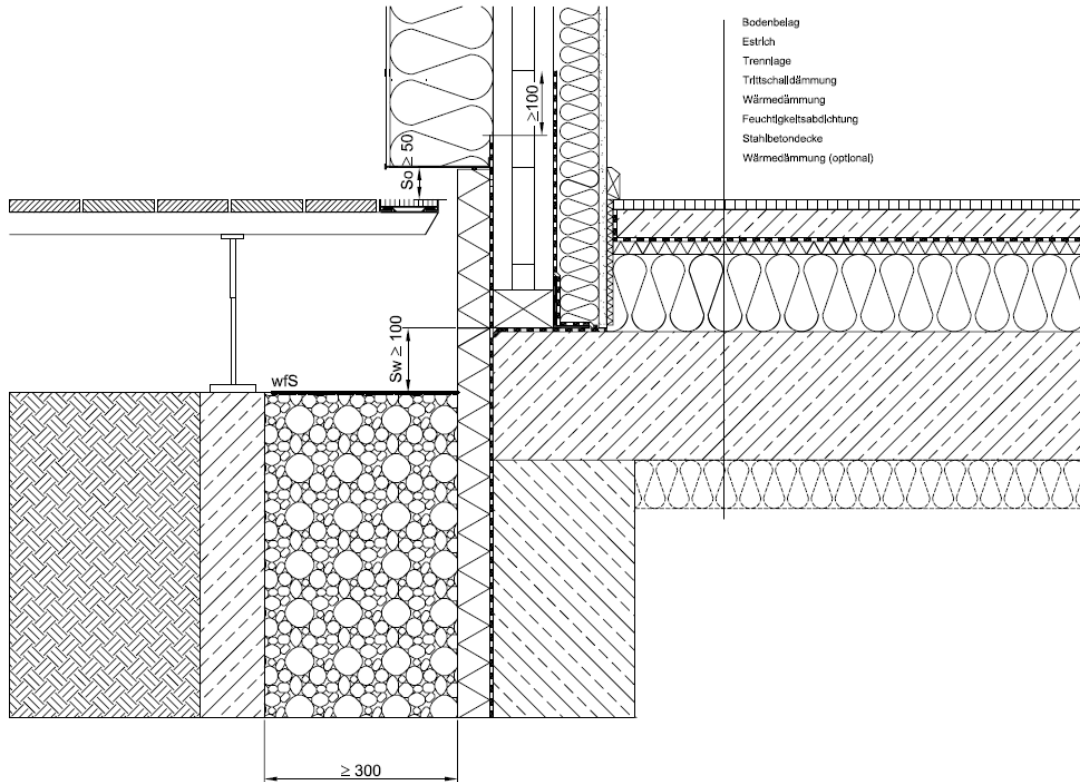

Figure 49: Detail of terrace connection

Further details for base connections have been elaborated on the basis of research work by Holzforschung Austria [Polleres und Schober 2009b] and can be found at www.dataholz.com or within ÖNORM B 2320.

8.1.2 Constructive Rules

8.1.2.1 Bitumen and larch threshold for ground floor wall



Figure 50: Support detail of an internal wall

A barrier layer against rising damp from the substructure, e.g. in the form of bitumen sheeting, is required between the foot sleepers or the cross-laminated timber and the mineral subsurface (foundation slab or basement ceiling). If a foot threshold is implemented, it should have a minimum thickness of 3 cm.

Base connection:

- A barrier layer shall be installed between wood and mineral base.
- A minimum value of 10 cm between threshold and ground or of 5 cm between threshold and water-bearing plane is possible in connection with the design of construction special measures (raising the external waterproofing ≥ 15 cm).

8.2 Window insertion

8.2.1 General

Window insertion generally represents a challenge in terms of construction building requirements in a small compass. The window shall be installed in the range of the 13° isotherm in the insulation plane. Installation flush with the facade increases the expenditure for planning, maintenance and repair and may cause the formation of condensate due to the unfavorable course of the isotherm. Thus, it should be avoided.

There are requirements concerning driving rain impermeability, air tightness, reduction of thermal bridges and sound protection. Driving rain impermeability and air tightness are tested according to design loads for the window based on [ÖNORM B 5300]. According to [ÖNORM B 5320], the attachment joint is regarded as air tight if the air flow at the maximum test pressure is lower than 0.4 m³/(m·h).

For testing air tightness of building shell on site, the blower door measurement is used according to [ÖNORM EN ISO 9972]. The measurement result, the so-called n₅₀ value indicates the air changes in 1/h for a pressure difference of 50 Pa. Measurements on site require extensive search for leakages. An exact quantification of additionally measured air flow velocities for air volume flows at individual leakages is enabled only if the leakage geometry is known. A blower door measurement cannot be compared to a test of the window according to [ÖNORM EN 1026] or the window attachment according to [ÖNORM B 5321].

8.2.2 Constructive Rules

The window attachment shall be sealed to be airtight on the inside and to be windproof on the external side. The intermediate space shall be filled up in a tight way and without leaving an empty cavity.

Experiences gained from expert opinions have shown that the window sill connection is of great importance with regard to driving rain impermeability, especially on wind-loaded sides. Investigations were carried out within the course of the research project Architecture versus Technology on the window sill connection for facades with WDVS [Polleres und Schober 2009a]. In addition to the importance of the processing of the WDVS and the connection of the window sill (e.g. decoupling of the end profile from the WDVS), a second water-bearing level (sealing level) under the window sill is required in accordance with ÖNORM B 2320, unless the system used ÖNORM B 5321].

A detailed guideline for the installation of window sills with WDVS and plaster facades as well as curtain walls has been issued by the Austrian Working Group Window Sill, [Österreichische Arbeitsgemeinschaft Fensterbank].

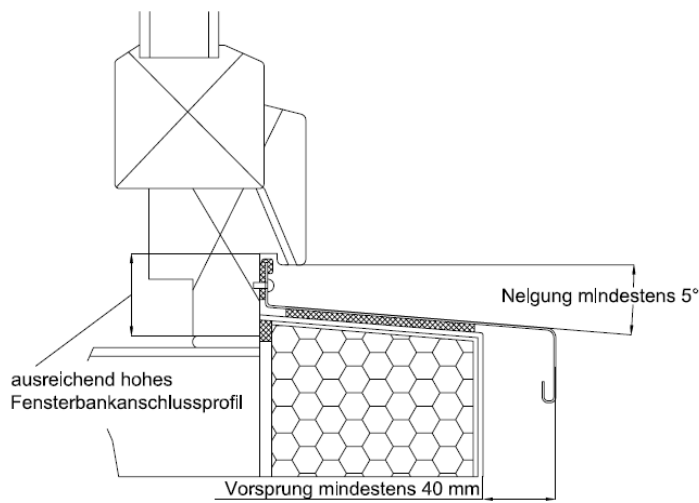

Figure 51: Window sill connection with sufficiently high window sill connection profile with at least 5° window sill inclination and a minimum facade overhang of 40 mm, source: [Österreichische Arbeitsgemeinschaft Fensterbank]

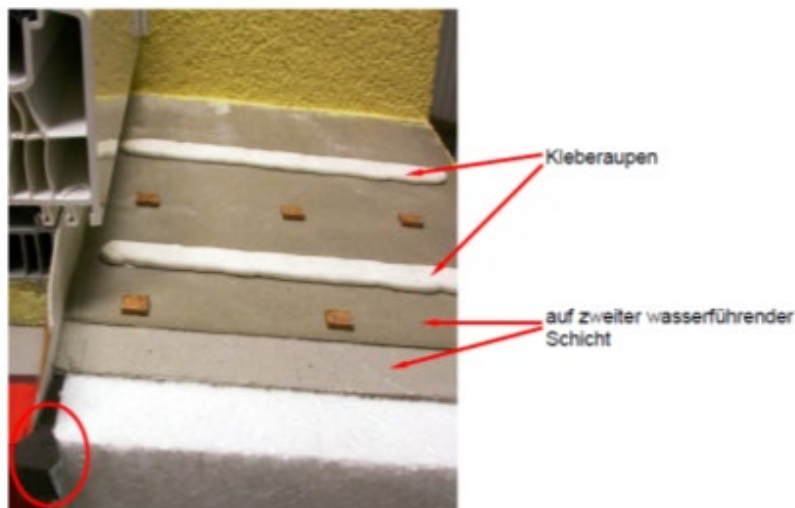

Figure 52 Windows sill installation on second sealing plane, bonded with adhesive beading. The resulting void spaces are admissible. The insulation material wedges / facade bead is connected with the window sill connection profile by means of a sealing tape (red circle Source: [Österreichische Arbeitsgemeinschaft Fensterbank])



Figure 53 Horizontal joint under window sill towards facade surface with permeable sealing tape. Can also be executed in open form Source: [Österreichische Arbeitsgemeinschaft Fensterbank]

For facades made of timber or wood materials, it is recommended to extend the reveal panel over the lateral window sill upstand. Details for the correct window sill connection for wood facades can be found in [Schober et.al 2010].

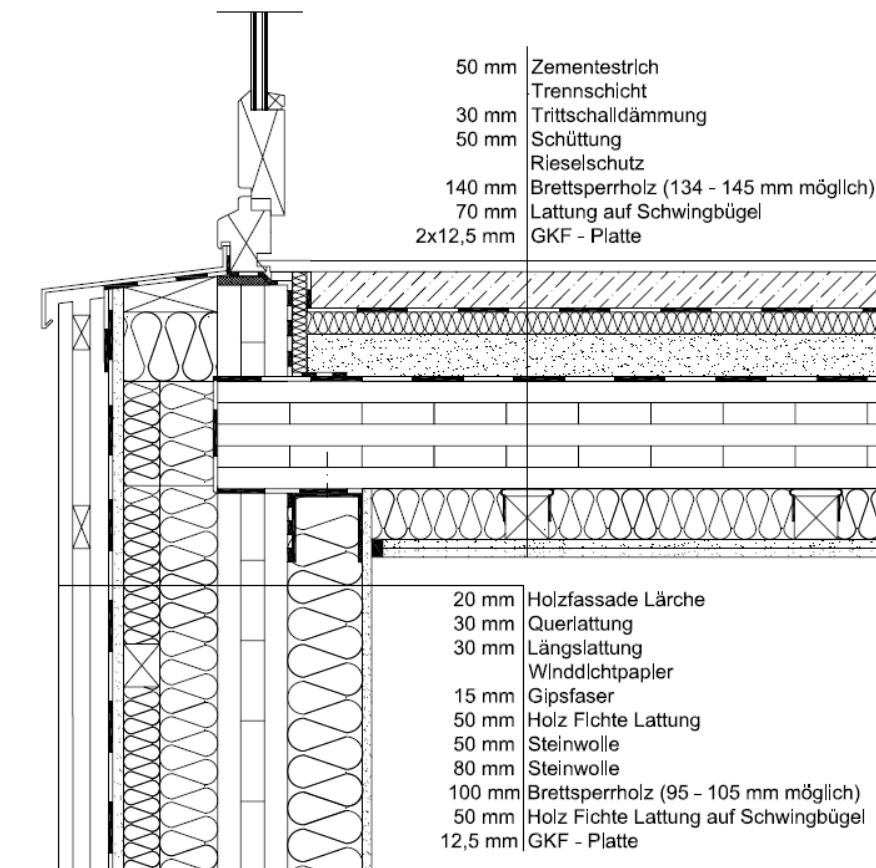

Figure 54: Example of a door connection for a French balcony

Window insertion:

- Windows shall be installed at or in the insulation plane.
- The connection needs to be airtight on the inside and rainproof on the outside. The joint shall be filled up without any gaps.
- As a rule, the window connection shall be executed less permeable on the inside than outside.
- Below the window sill, a second water-bearing plane is required, if the building connection does not have certification according to ÖNORM B 5320 or ÖNORM B 5321.

8.3 External wall corner

The connection of the outer wall corner is to be executed airtight. This requires sealing the joints of clad cross-laminated timber walls with adhesive tapes, else corresponding sealing tapes or profiles need to be inserted. This also applies to corners or edges. The pressure for air tightness is gained from the statically necessary screw connections of elements or through system connectors. As far as fire protection requirements are concerned, rules according to section 7.7. apply.



Figure 55: External wall corner: on the left, prefabrication (view); on the right, assembly (top view)

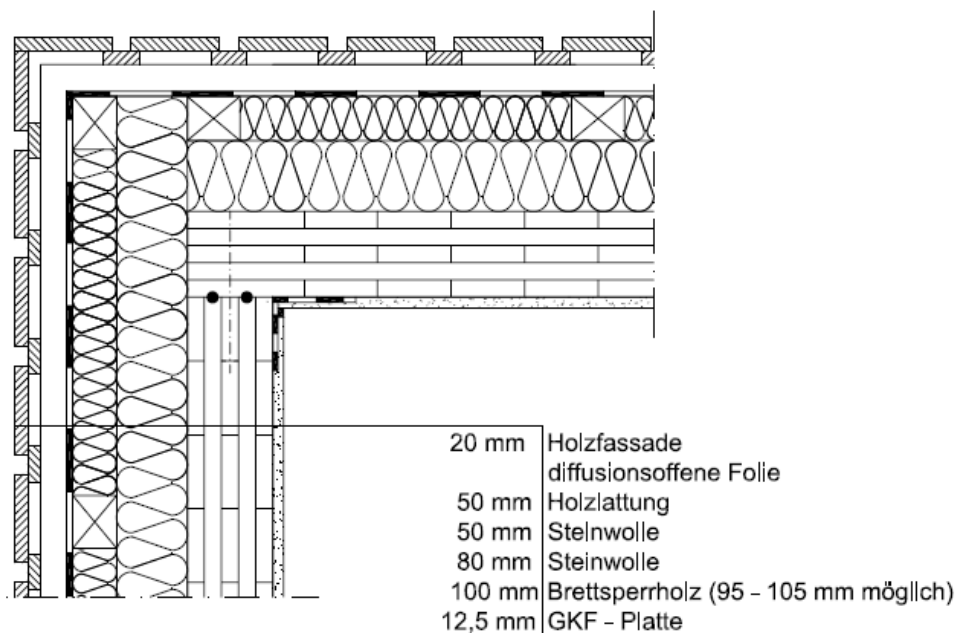

Figure 56: Exemplary execution of external wall corner

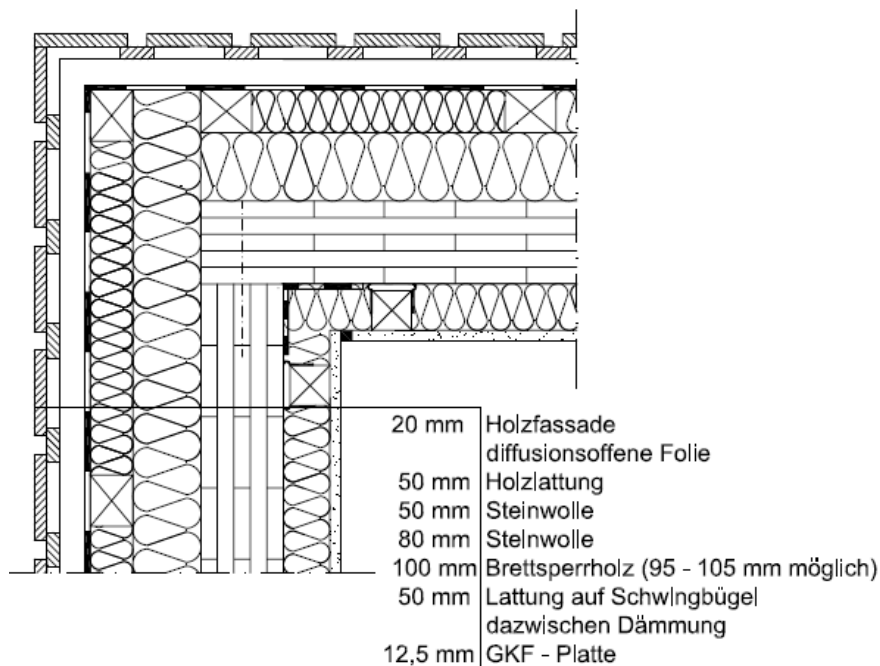

Figure 57: Exemplary execution of outer wall corner with installation level

External wall corner:

- The element butt joint shall be executed airtight with adhesive tapes or sealing tapes or profiles.
- Screw connection or connection with system connectors shall be done according to static requirements, with at least three screw connections are to be executed throughout element height.
- The degree of prefabrication shall be as high as possible while considering assembly technology.

8.4 Element butt joint

Element butt joints are usually executed for floor and roof elements using welted boards or rebated connections and for wall elements rebated connections.

During fire experiments as a basis for evaluating the fire resistance of solid timber extensions for dataholz.eu, a loaded large-scale experiment was carried out over 60 minutes on a 140 mm thick solid timber floor without any additional cladding with the connections mentioned, [Polleres und Schober 2004]. All of the joint constructions met the requirements. The remaining wood cross sections resulted as shown in Figure 58 and Figure 59.

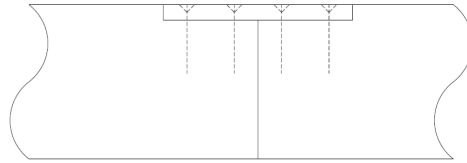

Figure 58: Remaining wood cross section in the joint area of welded boards

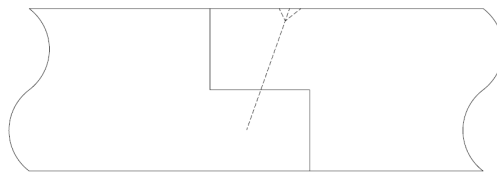
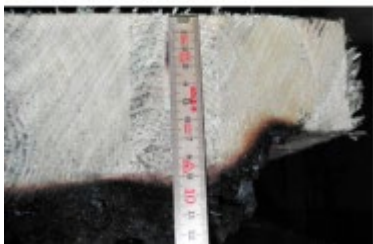

Figure 59: Remaining wood cross section in the joint area of rebated connections

According to [ÖNORM B 1995-1-2], cross-laminated timber components with

- rebated connections
- inserted spring
- topside welded board (only on floor and roof constructions) and
- potentially additional claddings on the offside of the fire

for the period till a minimum remaining wood cross section of 2 cm,

- rebated connection
- inserted spring
- topside welded board (only on floor and roof constructions)

can be classified without verification for integrity and heat insulation EI, see Figure 60. The verification of load-bearing capacity R has to be done separately for all cases.

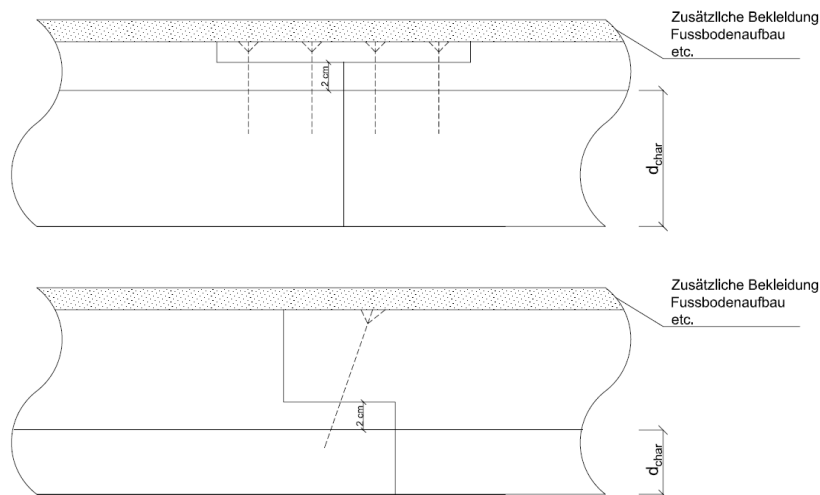

Figure 60: Element butt joint design of cross-laminated timber elements for verifying the integrity and heat insulation function, source: [ÖNORM B 1995-1-2]

To ensure air tightness of the building shell, sealing tapes are to be inserted at element butt joints or butt joints to be sealed with corresponding adhesive tapes.

Element butt joint:

- For wall elements, a rebated connection is to be executed.
- For floor elements, a connection can be created by means of rebated connection or topside welted board.
- Edge distances of fastening means shall be complied with.
- Butt joints at external and separating components shall be executed airtight with the use of adhesive tapes or sealing tapes.

8.5 Gypsum board connections

[ÖNORM B 2320] states that due to the swelling and shrinking behavior of wooden materials, tear gaps in edges cannot be excluded. Therefore, decoupled connections shall be formed in critical areas, e.g. in the area of connections between roof pitches and wall. This includes for instance embedded reinforcing strips and separating strips. The formation of connection joints as triangular joints made of silicone or acrylic materials is inadmissible.

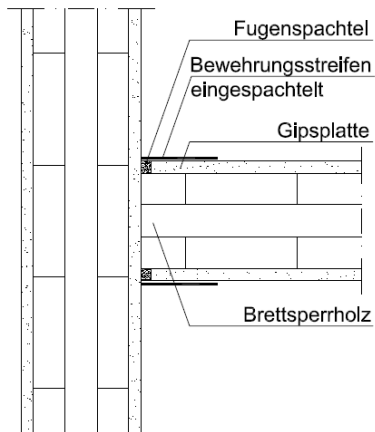

Figure 61: Connection details of a clad cross-laminated timber wall following [ÖNORM B 2320]

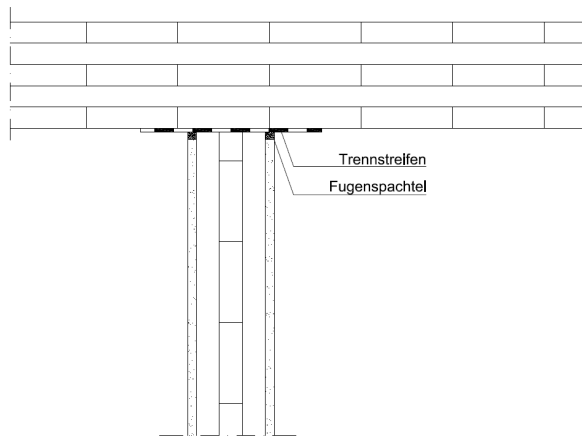

Figure 62: Connection detail of a clad cross-laminated timber wall to a floor construction following [ÖNORM B 2320]

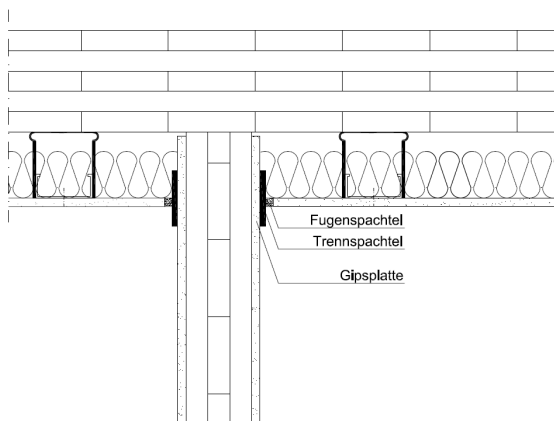

Figure 63: Connection detail of a clad cross-laminated timber wall to a suspended floor construction following [ÖNORM B 2320]

Gypsum board connections:

- Joints and connections are generally to be designed.
- Expansion joints of the building need to have constructively the same possibilities of movement.
- Gypsum components shall be constructively separated from other components.
- Suspended floors and floor claddings have to be constructively separated from tying-in supports, installation components.
- Expansion and movement joints shall be integrated into major component surfaces.
- Joints shall be arranged for marked cross section changes of cladding areas like hallway extensions or re-entrant walls.
- In case of movements of the shell construction (e.g. due to shrinkage, creeping, variable loads), gliding floor and wall connections shall be designed.
- It is necessary to schedule sufficient time for drying phases and for heating (winter!) in order to avoid shock-like temperature rises and decreases of humidity (this applies both for the construction phase and the beginning of utilization).

8.6 Separating floor support

8.6.1 General

From the view of sound protection, the principles stated in Table 28 apply also to separating floor supports with internal walls and external walls in cross-laminated timber constructions and for props. Details and characteristics for various supports can be taken from [Teibinger et al. 2009].

While there are no additional building physical requirements to internal wall supports, separating and external walls shall comply with the following additional requirements to fire protection and air tightness. Screw connections of elements need to be executed in a force-fitting manner where an axis spacing of 50 cm maximum is sufficient without any proof. In case of fire protection claddings, they require accurately fitting processing. Connection details can be taken from [ÖNORM B 2330]. Ensuring air tightness requires sealing measures of the connection joint, such as masking joints, insertion of sealing gaskets.

Table 28: Construction principles with regard to the necessity of elastic supports

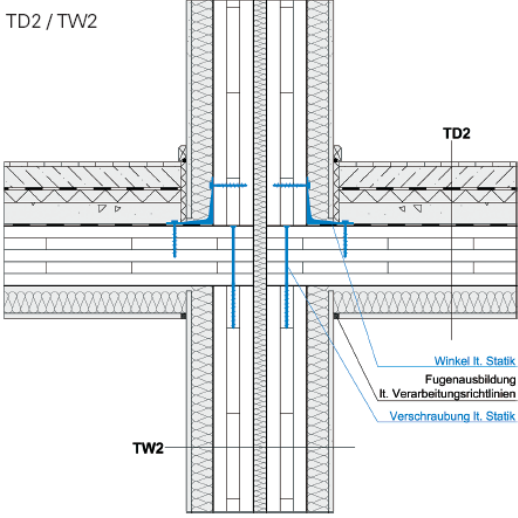
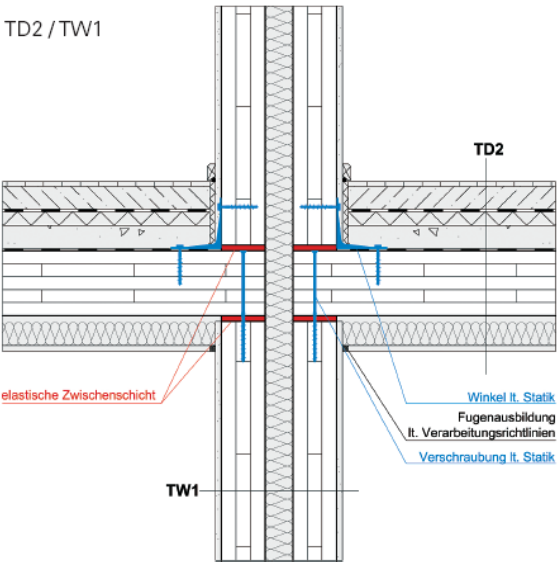
<p>TD2 / TW2</p>  <p>TD2</p> <p>TW2</p> <p>Winkel lt. Statik Fugenausbildung lt. Verarbeitungsrichtlinien Verschraubung lt. Statik</p>	<p>In case of a suspended floor bottom view and decoupled shells, no supports are required.</p>
<p>TD2 / TW1</p>  <p>TD2</p> <p>TW1</p> <p>elastische Zwischenschicht</p> <p>Winkel lt. Statik Fugenausbildung lt. Verarbeitungsrichtlinien Verschraubung lt. Statik</p>	<p>In case of a suspended bottom view on the floor and lack of decoupled shells on walls, elastic supports are required both above and below the floor.</p>

<p>TD1 / TW2</p>	<p>In case of cross-laminated timber floors with timber bottom view (without a suspended bottom view) and decoupled shells on walls, elastic supports are required above the floor.</p>
<p>TD1 / TW1</p>	<p>In case of cross-laminated timber floors with timber bottom view (without a suspended bottom view) and no decoupled shells on walls, elastic supports are required above the floor.</p>
<p>TD2 / TW3</p>	<p>Continuous floors across different units also require decoupled shells, suspended bottom views and elastic supports above and below the floor.</p>

8.6.2 Constructive Rules

8.6.2.1 Use of elastic supports for decoupling

Elastic supports are dimensioned according to loads where different supports result for individual stories. Supports shall be clearly assigned by coloring and lettering.



Figure 64: Sylomer supports in the padding support area for decoupling

8.6.2.2 Fastening of elastic padding supports using nails

Elastic padding supports shall be placed on elements or their position can be fixed through adhesive tapes. Fastening with nails, see Figure 65 is inadmissible.



Figure 65: Inadmissible fastening of the elastic padding support using nails

8.6.2.3 Screed insulating strips / edge insulating strips

The screed insulating strip shall be led to the raw floor.

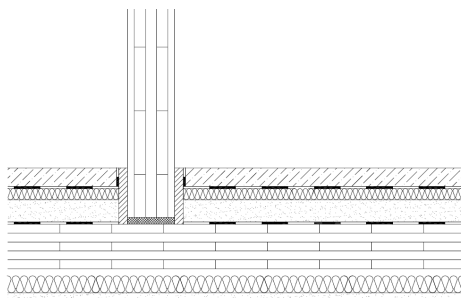

Figure 66: Lead edge insulating strip to the raw floor

8.6.2.4 Screed insulating strip cut too short

Filler that flowed into the space between screed and wall due to an edge insulating strip that was cut too short (prior to laying the cover) can deteriorate impact sound insulation by up to 6 dB [Köhnke 2012].

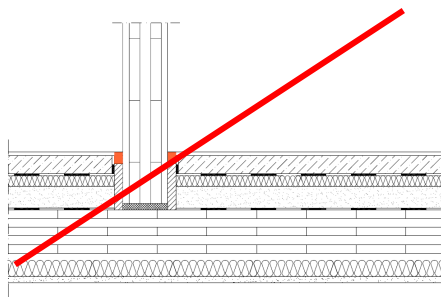

Figure 67: Coupling by filler due to screed insulating strips cut too short

8.6.2.5 Joint filler between wall and floor tiles

Insertion of joint filler between wall and floor tiles can cause a deterioration of impact sound insulation of up to 8 dB, [Köhnke 2012].

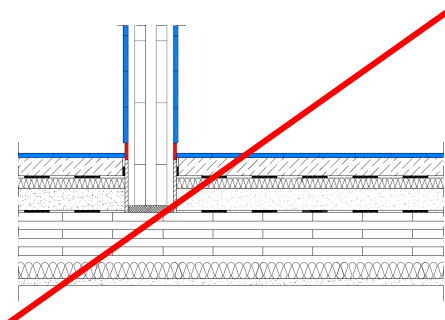

Figure 68: Joint filler between wall and floor tiles

Separating floor support:

- Decoupling to prevent flank sound transmission shall be ensured by means of shells, suspended floor and/or continuous elastic supports.
- Decoupling is also necessary for props.
- Elastic supports must not be mechanically fastened.
- Decoupled connection means improve sound protection.
- Screed insulating strips need to be extended to the raw floor and cut only after filling.
- A coupling between wall and floor covers has to be avoided.
- Force-fit screw connections of elements shall be ensured.
- Air tightness is to be considered. This requires the use of continuous supports and/or adhesive tapes or sealing tapes.
- Processing the fire protection cladding to the point of accurate fit shall be ensured.

8.7 Connection details for components forming fire compartments

8.7.1 Technical execution

Constructive details for wooden components forming fire compartments will be explained in a survey as follows. The details developed were derived from preliminary small-scale fire investigations of wall and floor connections in timber frame and solid timber constructions in accordance with the standard temperature curve (ETK) which were carried out within the scope of a research project of Holzforschung Austria [Teibinger und Matzinger 2008]. Connections were examined for a fire resistance of 60 minutes. All of the variants in timber frame and solid timber constructions complied with a fire resistance of 60 minutes, also in the connection joint area. With solid timber elements, it was possible to achieve fire resistances of 90 minutes.

Moreover, among others, seven loaded large-scale fire tests were carried out on cross-laminated timber walls with and without gypsum cladding in the course of another research project of Holzforschung Austria concerning the fire resistance of timber constructions [Teibinger und Matzinger 2010]. To insert loads, in all cases, an auxiliary floor construction as a cross-laminated timber construction clad with gypsum boards was mounted on wall elements with a screwing distance of 500 mm. No additional fire protection measures were carried out in the joint area between auxiliary floor and wall. In no case at all, there was increased combustion in the connection area or a failure in the joint area, with the test duration varying between 60 and 120 minutes.

Connection details for components forming fire compartments

- Elements need to be interconnected in a friction-locked way according to static requirements with a maximum distance of fasteners of 50 cm.
- Air tightness of connections shall be ensured by continuous supports and/or adhesive tapes.
- Fire protection claddings are to be processed to fit accurately.
- For capsule requirements to components and their connections of multilayer fire resistance claddings, butt joints need to be arranged shiftily.

8.7.2 Connection of the fire compartment forming partition wall to the external wall

With regard to detail design, the basic rules stated in section 8.7 apply. Additionally, the joint between the two walls needs to be filled up completely with stone wool.

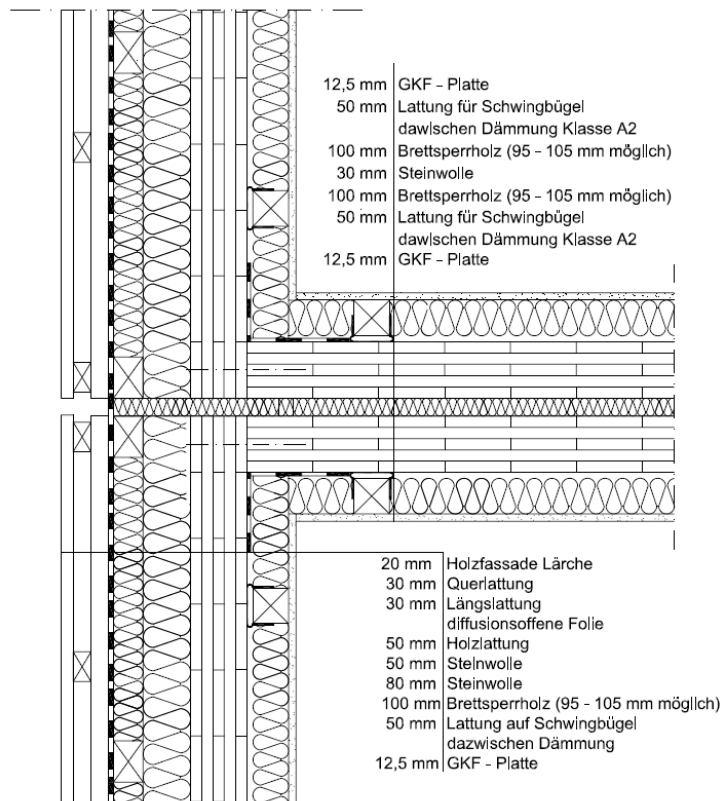

Figure 69: Connection of a fire compartment forming partition wall to an external wall. The external wall should have a fire resistance of 90 minutes at a point of 0.5 m away from the axis of the fire compartment forming wall

Connection of fire compartment forming partition wall to the external wall:

- Shells or a separation of the external is required for preventing flank transmission.
- The external wall should have the same fire resistance across at least 0.5 m from the axis of the fire compartment forming wall as the latter.
- Elements need to be interconnected in a friction-locked way according to static requirements with a maximum distance of fasteners of 50 cm.
- Air tightness of connections shall be ensured by continuous supports and/or adhesive tapes.
- Fire protection claddings are to be processed to fit accurately.
- For capsule requirements to components and their connections of multilayer fire resistance claddings, butt joints need to be arranged shiftily.
- Space ($\geq 5\text{cm}$) in double-leaf setups needs to be completely filled up with mineral wool for sound insulation.

8.7.3 Connection of the fire compartment forming separating floor to the external wall

If a separating floor is executed as a fire compartment forming component, the floor has to overhang by at least 80 cm for fire protection reasons and have the same fire resistance as the separating floor, and an external wall strip having a height of at least 120 cm has to be formed with the same fire resistance as the separating floor. The overhung floor construction is not recommended for building physical reasons. On principle, a floor slab can be spliced with thermal decoupling in front of the wall component. It is required there that the connection to the raw external wall and mounting comply with requirements to the fireplace resistance of the fire compartment forming floor, see Figure 68. From the construction mentioned and also architectural reasons, the design of an external wall strip of 120 cm height is often preferred. Regarding the requirement to the connection, the general principles stated in section 8.7 apply. Requirements to rear-ventilated, ventilated and non-ventilated timber facades are regulated in [ÖNORM B 2332] and summarized in section 8.9.

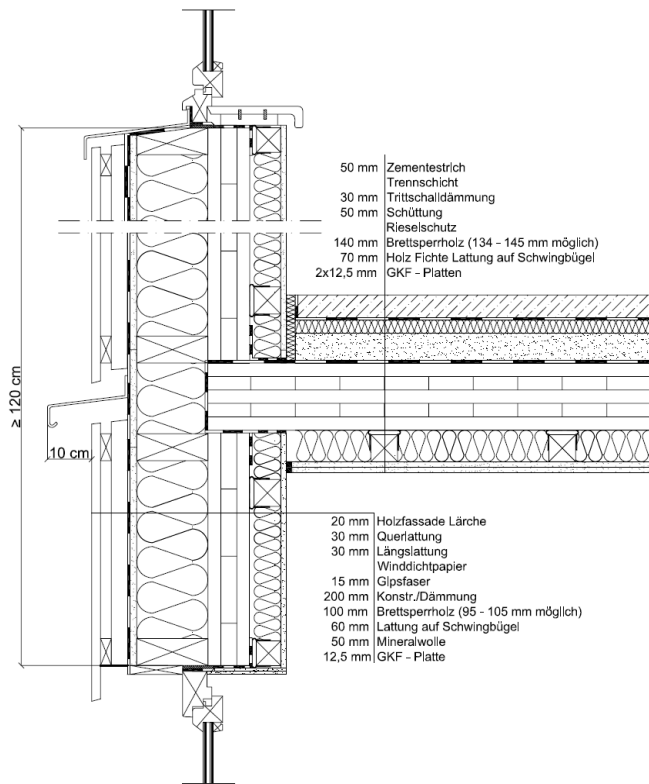

Figure 70: Exemplary connection of a fire compartment forming separation floor to the external wall (120cm external wall strip)

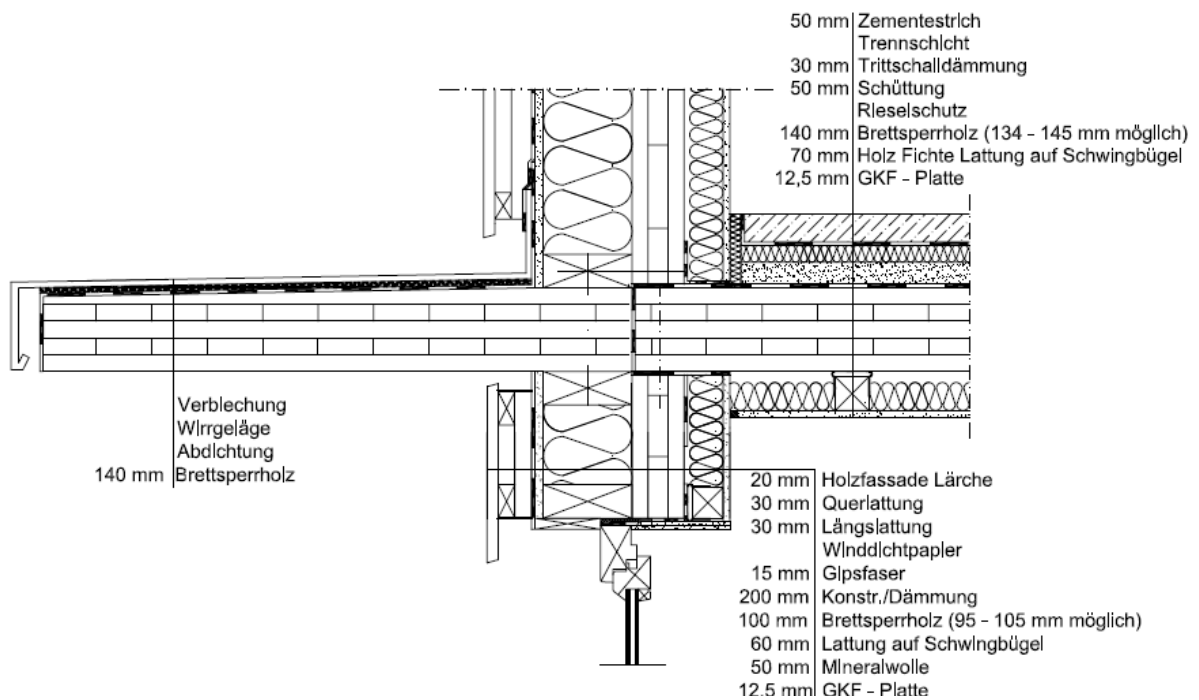

Figure 71: Exemplary connection of a fire compartment forming separation floor to the external wall (80cm overhang)

Connection of fire compartment forming separating floor to the external wall:

- Overhang of 80 cm of a cross-laminated timber floor is problematic from the view of building physics. Thus, the overhang shall be fastened to the raw construction to prevent fire transmission, where the connection and mounting shall have the same fire resistance as the fire compartment forming floor.
- Decoupling to prevent flank transmission shall be ensured through shells, suspended floor and/or continuous elastic supports, see also section 8.6.
- Elastic supports must not be mechanically fastened.
- Decoupled connection means improve sound protection.
- Screed insulating strips need to be extended to the raw floor and cut only after filling.
- A coupling between wall and floor covers has to be avoided.
- Elements need to be interconnected in a friction-locked way according to static requirements with a maximum distance of fasteners of 50 cm.
- Air tightness of connections shall be ensured by continuous supports and/or adhesive tapes.
- Fire protection claddings are to be processed to fit accurately.
- For capsule requirements to components and their connections of multilayer fire resistance claddings, butt joints need to be arranged shiftily.
- For buildings of building class 4, constructive solutions to prevent fire propagation (e.g. overhanging steel sheet or stone wool strips) are required on the facade, see also section 7.9.

8.7.4 Connection of the fire compartment forming partition wall to the floor

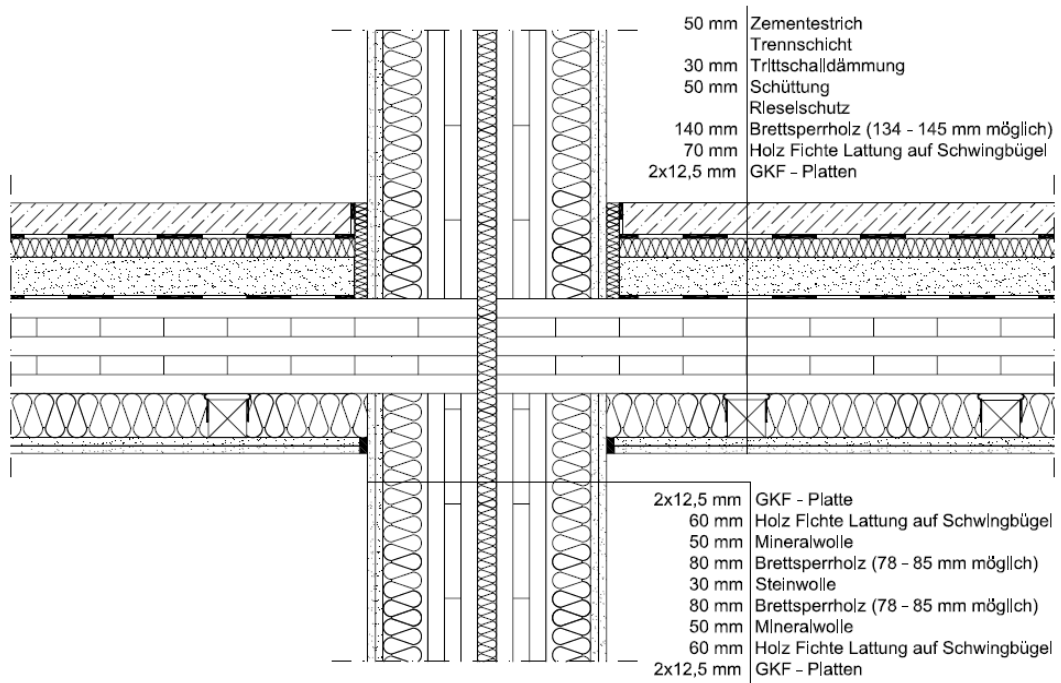

Figure 72: Exemplary connection of a fire compartment forming partition wall to a separating floor

Connection of fire compartment forming partition wall to the floor:

- Decoupling to prevent flank transmission shall be ensured through shells, suspended floor and/or continuous elastic supports, see also section 7.6.
- Elastic supports must not be mechanically fastened.
- Decoupled connection means improve sound protection.
- Screed insulating strips need to be extended to the raw floor and cut only after filling.
- A coupling between wall and floor covers has to be avoided.
- Elements need to be interconnected in a friction-locked way according to static requirements with a maximum distance of fasteners of 50cm.
- Air tightness of connections shall be ensured by continuous supports and/or adhesive tapes.
- Fire protection claddings are to be processed to fit accurately.
- For capsule requirements to components and their connections of multilayer fire resistance claddings, butt joints need to be arranged shiftily.
- Space (≥ 5 cm) in double-leaf setups needs to be completely filled up with mineral wool for sound insulation.

8.7.5 Connection of the fire compartment forming partition wall to the roof

According to OIB Guideline 2, fire compartment forming walls need to be extended at least 15 cm above the roof, unless fire propagation is restricted by other measures.

If the roof runs without inclines across the fire compartment forming wall, cavities in the area of counter battens on both sides shall be completely filled up with mineral wool, melting point $\geq 1000^{\circ}\text{C}$ (stone wool), over a length of at least 50 cm from the center of the fire compartment forming wall. Roof covering shall be laid in a mortar bed in the area of the fire compartment forming wall, or mineral wool having a melting point $\geq 1000^{\circ}\text{C}$ (stone wool) shall be inserted, too. Battens can be laid in the area of stone wool insulation, where roof battens and formwork shall be interrupted directly under tin roofs in the area of the fire compartment forming wall and joints shall be filled up also with mineral wool, melting point $\geq 1000^{\circ}\text{C}$ (stone wool). The combustible close boarding shall be replaced by a non-combustible cladding (e.g. gypsum fiberboard) in the area of the fire compartment forming wall.

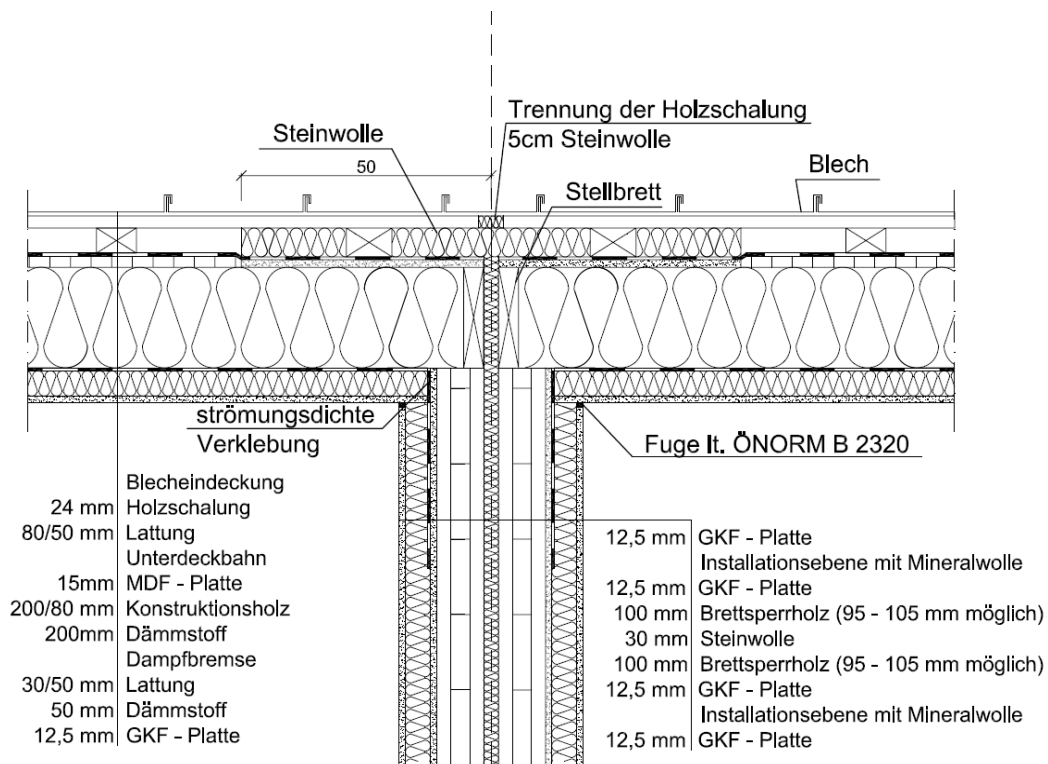

Figure 73: Exemplary connection of a fire compartment forming partition wall to a tin roof

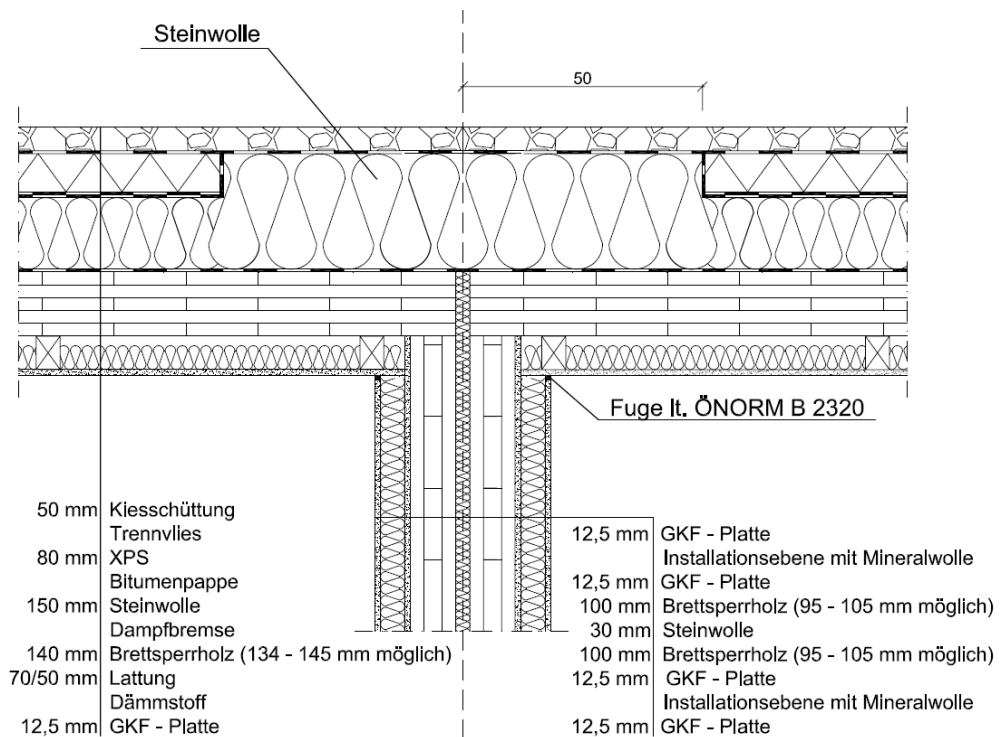

Figure 74: Exemplary connection of a fire compartment forming wall to a flat sloping roof with on-roof insulation

Connection of a fire compartment forming partition wall to roof:

- The fire compartment forming wall shall be extended to at least 15 cm above the roof. The inclines can be renounced if stone wool insulation is used across at least 50 cm from the axis of the fire compartment. Possible back-ventilated cross sections shall be likewise filled up with insulation. External wooden casing shall be replaced with gypsum fiberboards. See also Figure 73 and Figure 74.
- In case of continuous roof elements (separating floor) running across the partition wall, a suspension is required for decoupling and sound protection reasons.
- Elements need to be interconnected in a friction-locked way according to static requirements with a maximum distance of fasteners of 50 cm.
- Air tightness of connections shall be ensured by continuous supports and/or adhesive tapes.
- Fire protection claddings are to be processed to fit accurately.
- For capsule requirements to components and their connections of multilayer fire resistance claddings, butt joints need to be arranged shiftily.
- Space (≥ 5 cm) in double-leaf setups needs to be completely filled up with mineral wool for sound insulation.

8.8 Penetrations

8.8.1 Vertical distribution

Shafts are used for vertical distribution of installations across individual units or fire compartments. Regarding the location of partitioning measures of penetrations, a distinction is made between shaft type A and shaft type B.

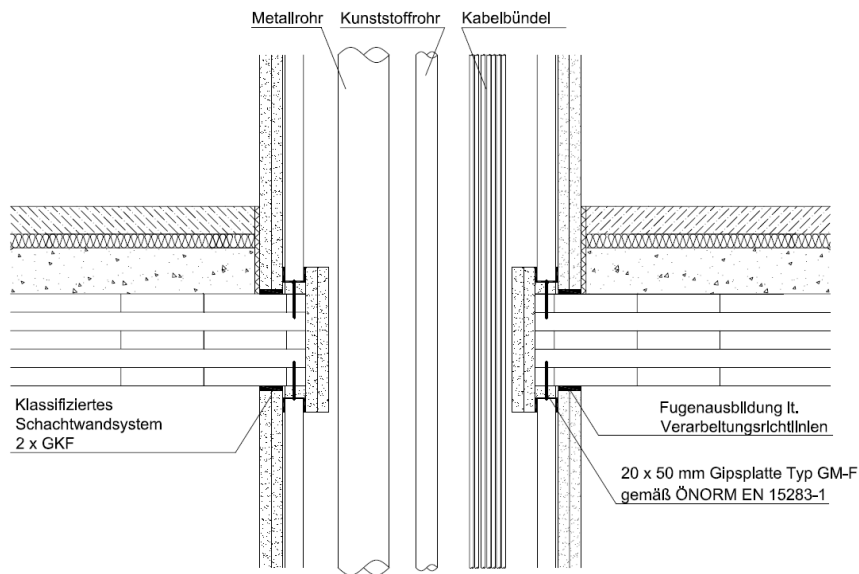

Figure 76: Exemplary design of a penetration of shaft type A for a solid timber floor

The reveal of the floor opening shall be clad with non-combustible material where GKF boards of at least 2 x 12.5mm are to be used. It has to be ensured that the gypsum reveal cladding rests on wood over its entire surface. Otherwise wood surface and the joint between gypsum and wood have to be coated with an intumescent product. Intumescent products cause residual openings to be closed by foaming on thermal loads and thus prevent the passage of smoke and toxic gases.

If corners of the opening are not provided with sharp edges due to production conditions, edges of gypsum boards need to be adapted and the joint is to be coated, too. In the connection area of the tested and classified shaft wall adjoining wooden elements, a strip of a gypsum board of 50 mm width and 20 mm thickness, type GM-F (e.g. fireboard) according to [ÖNORM EN 15283-1] shall be fastened on the shaft inside to the wood floor.

8.8.1.2 Shaft type B

There are no fire protection requirements to shaft walls for this type. The shaft is partitioned horizontally for every story according to the requirements to the floor fire resistance. The partitioning systems can include soft and hard partitions in combination with fire pipe collar, line section insulation and the like.

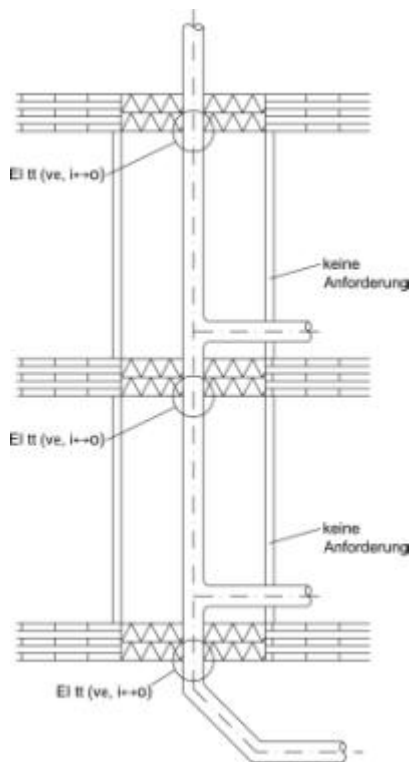

Figure 77: Schematic diagram of shaft type B, source: [Installationen-Richtlinie MA 37]

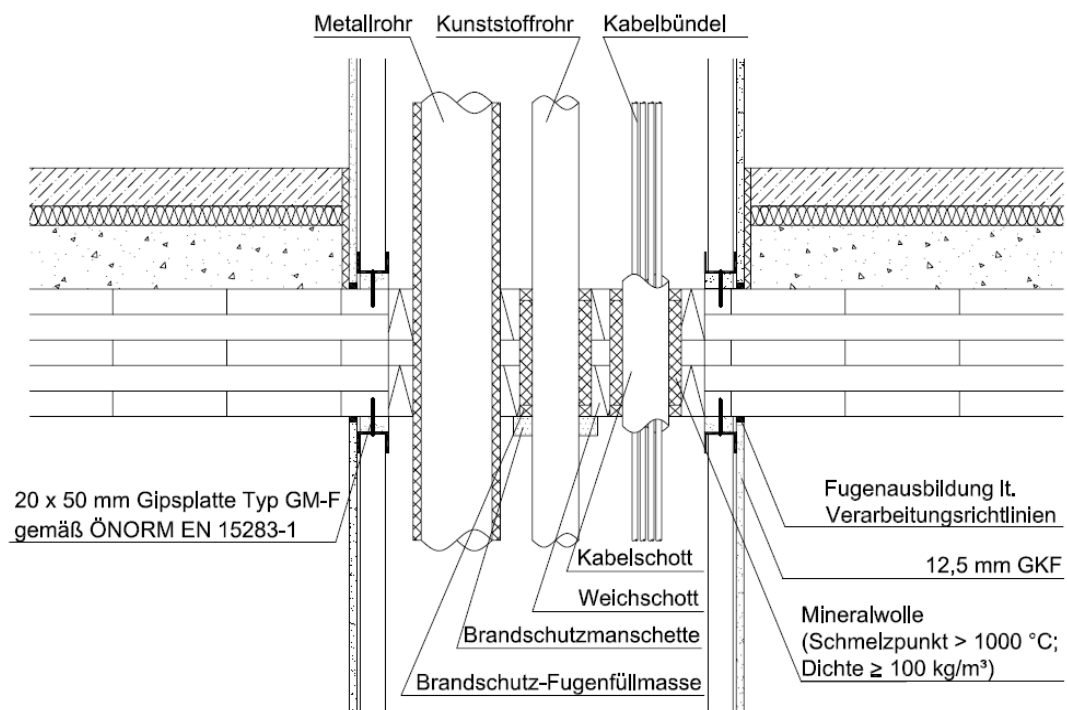

Figure 78: Exemplary design of horizontal partitioning in the area of a solid timber floor (shaft type B)

On the floor lower surface, a strip of a gypsum board, 50 mm wide and 20 mm thick, type GM-F (e.g. fireboard) according to [ÖNORM EN 15283-1] shall be fastened to the timber floor, see

Figure 78. The floor reveal need not be clad in the partitioning area. Wood surfaces that are exposed in the shaft have to be clad with non-combustible material.

8.8.2 Constructive Rules

8.8.2.1 Exact early planning of shafts

Domestic pipes and lines as well as their laying shall be considered at an early stage of planning. This generally applies also to the size of required shafts. Later replanning on site increases construction cost and decreases execution quality.



Figure 79: Incorrect execution: Due to a later extension of the shaft, non-combustible cladding of the wooden beam inside the shaft is not possible

8.8.2.2 No cladding all over of floor openings

Reveal covering of openings in the area of penetrations has to be attached over its entire surface. If this is not the case, the joint has to be coated with intumescent paints. If a soft partition is used, covering the reveal is not necessary; it can be even counterproductive if it is attached not over its entire surface.



Figure 80: Installation of a reveal covering not over its entire surface

8.8.2.3 Decoupling of reveal attachments



Figure 81: Sound protection decoupling of pipes

Shaft design:

- Shaft sizes should be planned early.
- Shafts shall be clad on the inside with non-combustible material.
- Shaft adjoining walls need to comply on both sides with the same fire resistance as that required for the shaft wall.
- Lines and pipes shall be decoupled in terms of sound propagation.
- In the connection area between timber floor and shaft cladding, 50 mm wide and 20 mm thick strips of gypsum boards type GM-F (e.g. fireboard) need to be attached, see Figure 76 or Figure 78.
- Shaft type A:
The floor cutout shall be clad with GKF of at least 2 x 12.5 mm. The reveal cover is to be attached over its entire surface.
- Shaft type B:
In the floor area, soft or hard partitions (classified systems) have to be installed. In case of soft partitions, no reveal covering is required. The configuration density according to classification reports shall be complied with.

8.8.3 Horizontal distribution

The horizontal distribution of installations in story-wise fire compartments must not be implemented within the fire protection effective component cross sections. Distribution shall be executed in corresponding installation planes, such as suspended floors, front-wall constructions or floor structures. Penetrations shall be partitioned off by fire compartment forming components.

8.8.4 Partitioning systems through fire compartments

If pipes and/or lines lead through fire compartment forming components or partitioning components, penetrations shall have the same fire resistance as the components. Figure 79 shows a survey of partitioning systems in terms of applicability. If several lines or pipes are laid in a shaft, frequently soft or hard partitions are used for story-wise partitioning in combination, for instance with fire pipe collars or section insulation. The maximum admissible configuration density - area of penetrations divided by area of the partition - shall be complied with. The average configuration density is about 60%. Details can be found in classification reports and technical information of suppliers.

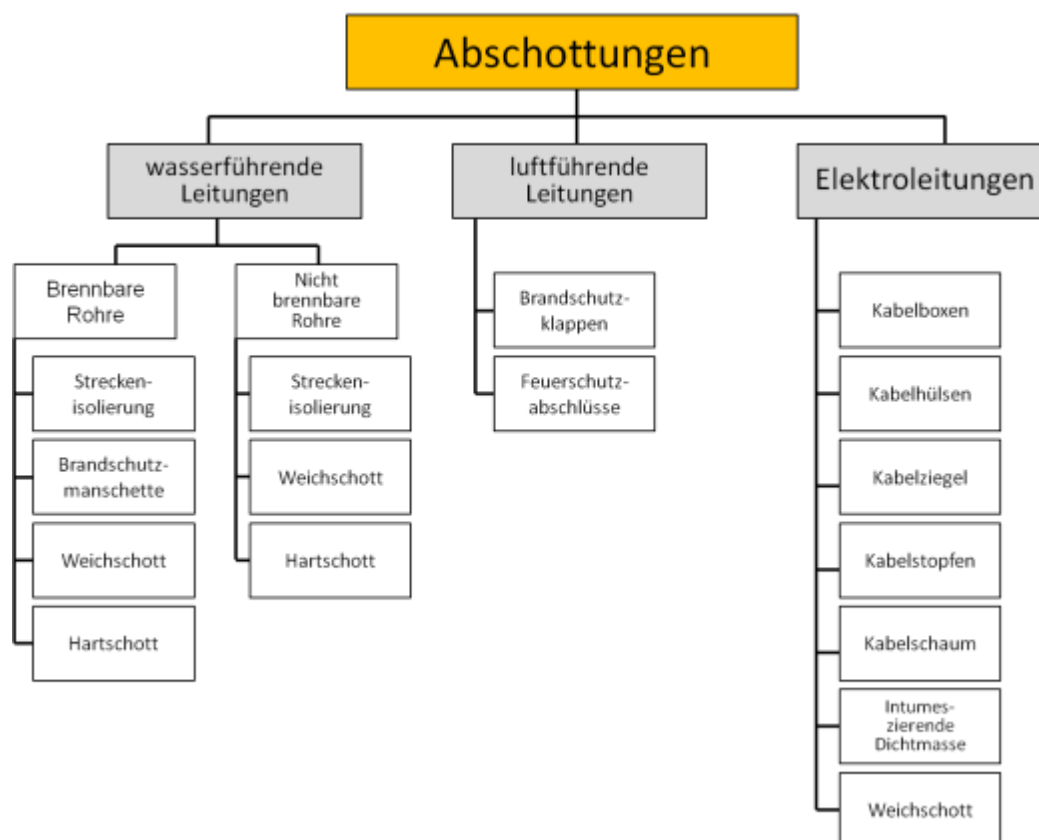

Figure 82: Survey of partitioning systems for water and air-bearing lines and electric cables

8.8.4.1 Hard and soft partitions

For soft partitions, coated mineral wool having a minimum gross density of 150 kg/m³ and a melting point of ≥ 1000 °C is used. At least 2 x 50 mm thick boards for EI 90 and an at least 60 mm thick board for EI 60 are used. The surface of boards and the joints between boards as well as connections are coated with intumescent or ablative paints. An essential advantage of soft partitions is that a later installation of lines or pipes can be relatively easily implemented as compared to hard partitions, depending on the admissible configuration density.

Hard partitions usually mean to denote gypsum or cement mortar. To ensure a permanent connection between component and hard partition, frequently reinforcement bars or threaded bars are used.

Hard and soft partitions are tested according to [ÖNORM EN 1366-3] and classified according to [ÖNORM EN 13501-2]. Specific additional tests, such as proofs of the weighted sound insulation value and air tightness can be requested directly from manufacturers.

The installation of soft partitions is possible with or without reveal covering of wooden elements. It shall be ensured that when a gypsum reveal covering is executed, it has to contact the wood over its entire surface. Otherwise wood surface and the joint between gypsum and wood have to be coated as well. If corners of the opening are not provided with sharp edges due to production conditions, edges of gypsum boards need to be adapted and the joint is to be coated.

The reveal (gypsum or wood surface) and lateral edges of the mineral fiberboard shall be provided with an intumescent or ablative coating.



Figure 83: Installation of the soft partition in a sample body (left: reveal covering center: Installation of the mineral fiberboards that is coated on its edges, right: Overcoating of surface beyond the edge of 20mm)



Figure 84: Application of coating on reveal and reveal coating, source: Würth company

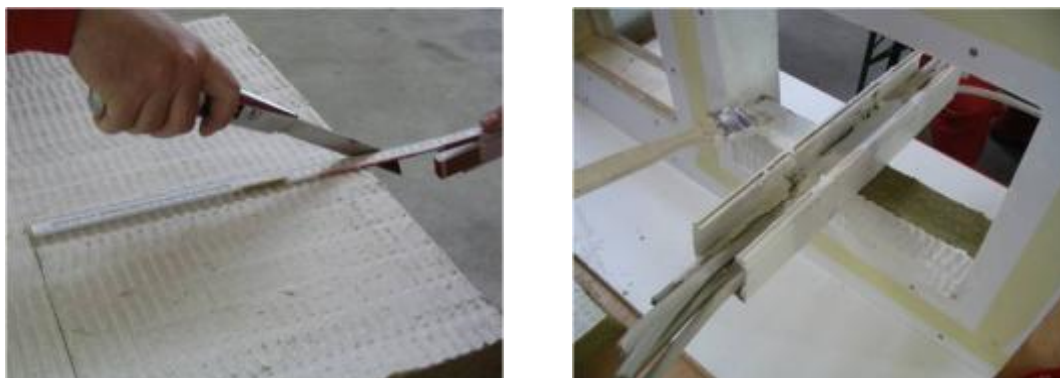

Figure 85: Cut to size of mineral fiberboard and coating of boards and reveal, source: Würth company



Figure 86: Sealing of cable penetrations and finished partitioning, source: Würth company

Installation of a soft partition:

- The reveal shall be provided with intumescent or ablative coatings according to manufacturers' instructions.
- If a gypsum cladding is applied on the reveal, this is to be done over its entire surface.
- Classified systems are required to be used.
- Soft partition:
EI at least 1 x 60 mm; EI 90 at least 2 x 50 mm
Manufacturers' data or proofs shall be considered.
- Surfaces, joints between boards and connections are to be coated with intumescent or ablating systems.
- The maximum admissible configuration densities according to classification reports shall be complied with.
- Penetrations shall be partitioned off, where fire protection collars and non-combustible section insulation are used for combustible pipes.

8.8.4.2 Partitioning systems for water-bearing pipes as well as sanitary and heating lines. With regard to the partitioning of pipe systems, a distinction is to be made between combustible and non-combustible pipes. With combustible pipes, fire protection collars can be used for partitioning. They consist of a steel jacket which is filled up with intumescent material. In case of a fire, the intumescent material foams at about 170 °C to 180 °C, encloses the combustible pipe and closes the opening. For shells (≤ 50 mm), the fire protection collar shall be mounted on the shell and fastened in the raw wall. In case of thicker facing walls, special solutions of manufacturers are required according to their tests. In case of floor cutouts, it is sufficient to

mount a fire protection collar on the floor underside. In case of horizontal penetrations, e.g. partition walls, fire protection collars shall be used on either side. Local building regulations and installation guides of manufacturers shall be considered.

A distinction is made between put-on and inserted fire protection collars. The latter are directly integrated into the component.

Specific additional tests (for instance for air tightness) can be requested directly from manufacturers.

Fire protection collars shall be fastened directly in the component. In case of solid timber, the length of the fastener has to be at least 10 mm inside unburnt wood in case of a fire. When fire protection collars are installed in soft partitions, threaded rods are to be used. For a direct installation through wooden elements, the annular gap between wood and pipe shall be sealed with mineral wool (melting point ≥ 1000 °C and gross density ≥ 40 kg/m³) where the mineral wool insulation is to be compacted to about 100 kg/m³. The external end shall be filled with an intumescent fire protection compound down to about 15 mm depth in the construction.



Figure 87: Installation of a fire protection collar directly in an unclad solid timber wall; left: Filling up the annular gap, center: intumescent fire protection compound, right: fastening of the fire protection collar

If a fire protection collar is installed in a shell, it has to be fastened in the load-bearing component.

If fire protection collars are installed in soft partitions, they must not be fastened in the partition. They are fastened either in the load-bearing partitioning component or threaded rods shall be led through the partition.

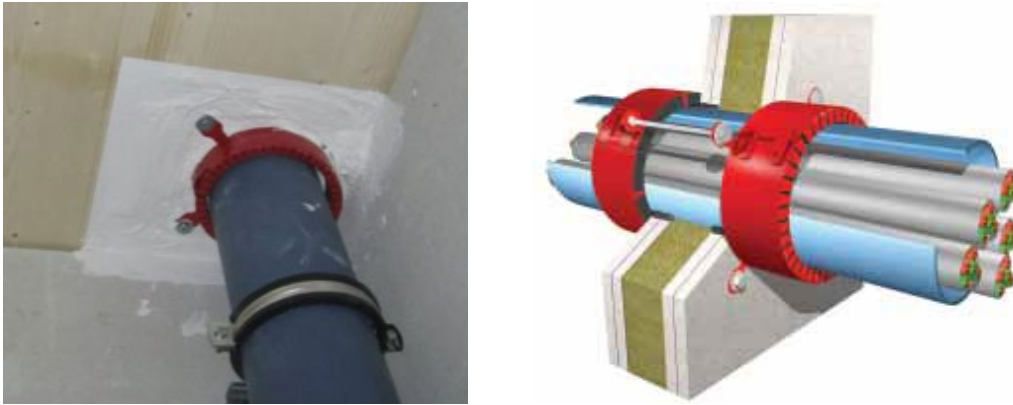

Figure 88: Fastening of a fire protection collar in a soft partition is admissible only if it is led through, source: bip company

Partitioning off of water-bearing pipes, sanitary and heating lines:

- Combustible pipes being led through fire compartment forming components shall be partitioned off with fire protection collars. For walls, a fire protection collar is required on either side. For floors, one fire protection collar is sufficient on the underside.
- If a put-on fire protection collar is directly installed in solid timber elements, an annular gap of ca. 10 mm shall be stuffed with stone wool. Stone wool shall be compacted and the joint filled to a depth of 15 mm with an intumescent fire protection compound. The fire protection collar shall be fastened directly in the solid timber element where the length of the fastener shall exceed maximum burn-off loss by at least 10 mm. For details on burn-off, see 3.4.2.
- For installation in a soft partition, continuous threaded rods shall be used for fastening.
- For shells ($\leq 50\text{mm}$), the fire protection collar shall be mounted on the shell and fastened in the raw wall. In case of thicker facing walls, special solutions of manufacturers are required according to their tests.
- Multiple configurations or special applications of fire pro collars with combustible and non-combustible pipes are possible depending on products and their proofs.
- Non-combustible pipes or lines that penetrate fire compartment forming components shall be partitioned off with section insulation. For this, stone wool insulation (melting point $\geq 1000\text{ °C}$) faced with aluminum is used.
- In case of copper cables, section insulation shall be installed always on both sides across at least 1m. For all other non-combustible lines up to a diameter $< 114\text{ mm}$, section installation shall be installed on both sides across 0.5 m and for a diameter $\geq 114\text{ mm}$, on both sides across 1 m.

8.8.4.3 Partitioning-off for ventilation lines

If ventilation lines penetrate fire compartment forming components, fire dampers and fire protection closures shall be installed. Fire dampers and fire protection closures have temperature-dependent release devices. Additionally, it is recommended also to integrate a smoke-sensitive, remote-controlled release. Remote control can be opened for control purposes within the scope of a function control which is to be repeated at regular intervals. After a temperature-dependent release which occurs at 70 °C to 75 °C, it shall be excluded to be able to open the damper by remote control.

In non-loadbearing components, fire dampers may be installed only if combined with expansion compensation measures that ensure that the position of the fire damper is not changed by thermal expansion or pipelines falling down. These measures shall be installed outside the movement area of the fire damper, but within a distance of one meter. Details can be found in [ÖNORM H 6031]. If the dampers are rigidly connected with loadbearing components, they may be installed without any expansion compensation measures. The connection shall be able to accept forces such that no deformation or damage to the damper and the soft partition can occur.

Besides ventilation flaps, fire protection closures based on intumescent materials with and without mechanical closing elements are used in Austria for ventilation lines depending on the admissible scope of application. They may be used only up to a maximum rated width of 160 mm in ventilation lines. Fire protection closures without a mechanical closing element (FLI) may be installed exclusively horizontally in ventilation systems for ventilating several apartments and rooms with residential use arranged one above the other. Fire protection closures with a mechanical closing element (FLI-VE) may be used horizontally and vertically in ventilation systems for ventilating living spaces, kitchens, rooms with residential use or wet rooms. Fire protection closures do not require regular check tests for the cases of application according to [ÖNORM H 6027].

Intumescent materials have a reaction temperature of about 150 °C to 170 °C. Therefore, a combination with cold-smoke barriers is recommended. The reaction temperature of closing elements is 70 °C to 75 °C.

The installation of fire protection closures based on intumescent materials in non-loadbearing walls (e.g. shaft walls) requires the use of elastic connection elements which are to ensure in case of fire the separation of the ventilation line from the fire protection closure. This connection part shall have a length of 1% of the line length connected according to [ÖNORM H 6027], but at least 80 mm. Details can be found in [ÖNORM H 6027].

While for ventilation flaps the position of the connection element is apparent from outside, the position of the connection element is impossible to evaluate from outside for fire protection closures based on intumescent materials.



Figure 89: View of a fire protection closure based on intumescent materials with closing element (FLI-VE)



Figure 90: Insulation of the annular gap between ventilation pipe and wooden component with stone wool (center), application of an intumescent fire protection compound with a depth of about 15mm (right)

For a direct installation through wooden elements, the annular gap between wood and pipe (e.g. spiral pipe) shall be sealed with mineral wool (melting point $\geq 1000\text{ }^{\circ}\text{C}$ and gross density $\geq 40\text{ kg/m}^3$) where the mineral wool insulation is to be compacted to about 100 kg/m^3 . The external end shall be filled with an intumescent fire protection compound down to about 15 mm depth in the construction. The minimum anchoring length of fasteners in unburnt wood has to be at least 10 mm depending on the fire resistance period required.



Figure 91: Rigid fastening of the ventilation pipe in the wood floor (left), fire protection closure based on intumescent materials with closing element FLI-VE (center), installation in sample body (right)

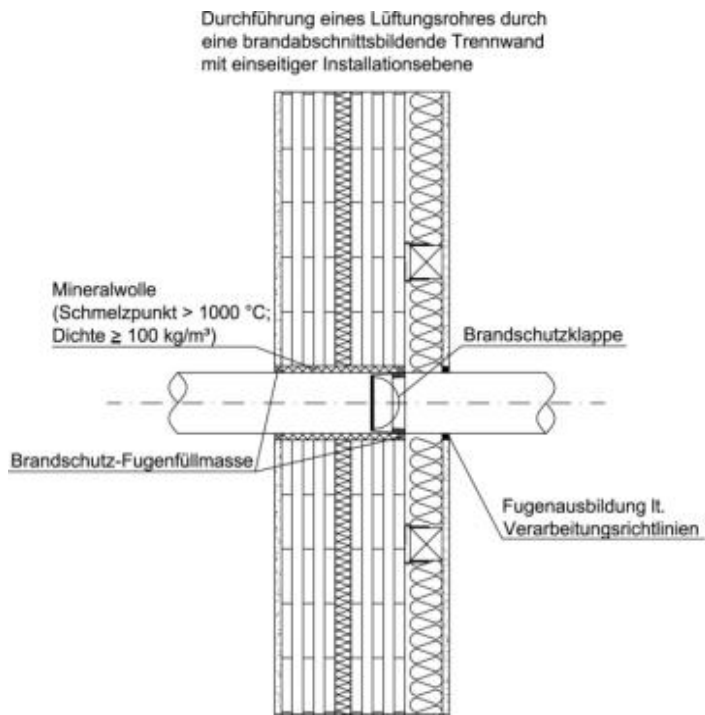

Figure 92: Installation of a fire protection flap in a fire compartment forming partition wall

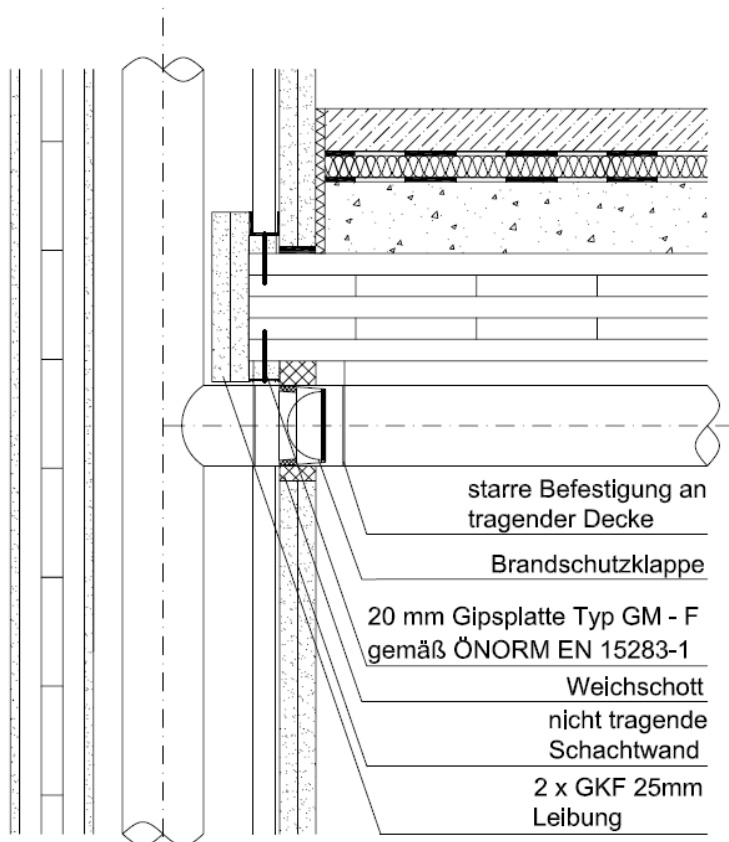

Figure 93: Installation of a fire protection flap in a shaft wall

Partitioning of ventilation lines:

- The use of fire protection closures based on intumescent materials without a mechanical closing element (FLI) is admissible only horizontally in ventilation systems (maximum rated width: 160 mm) for ventilating several apartments arranged one above the other.
- The use of fire protection closures based on intumescent materials with a mechanical closing element (FLI-VE) is admissible only horizontally and vertically in ventilation systems (maximum rated width: 160 mm) for ventilating living rooms, kitchens, wet rooms.
- In case of a direct installation in a solid timber element, an annular gap of about 10 mm shall be stuffed with stone wool. Stone wool shall be compacted and the joint filled to a depth of 15 mm with an intumescent fire protection compound. The fire protection collar shall be fastened directly in the solid timber element where the length of the fastener shall exceed maximum burn-off loss by at least 10 mm. For details on burn-off, see 3.4.2.
- Non-loadbearing components require expansion compensation measures.
- Details on the installation of fire protection closures can be found in ÖNORM H 6027 and on the installation of fire protection flaps in ÖNORM H 6031.

8.8.4.4 Partitioning systems for electric lines

Electric lines include besides power cables also communication lines and EDP lines. They can be partitioned off by means of fire stop cushions, fire protection foams, fire stop bricks with fire stop filling compounds, fire protection mortars, fire protection coatings of cables, intumescent fire protection compounds and the like.

Partitioning systems for electric lines can be used also in wood constructions if installation guidelines of manufacturers and test or classification reports are considered.

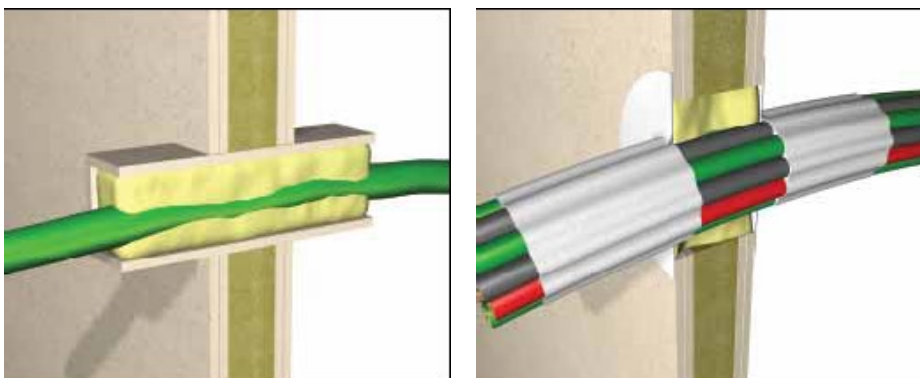

Figure 94: Examples of partitions by means of fire protection foam for electric cables, source: bip company



Figure 95: Fire protection foam used as a means of partitioning off cables and pipes, source: Hilti company

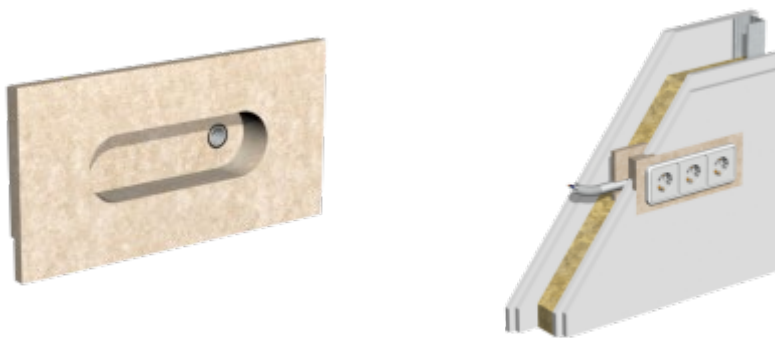

Figure 96: Examples of installation of wall sockets, source: Air Fire Tech company



Figure 97: Hollow wall box with intumescent of the Kaiser company, before and after fire exposure (source: https://assets.kaiser-elektro.de/media/11/113/KAISER_Brandschutz_Broschuere_2018_DE_web.pdf)

Electrical lines are to be routed in empty piping or double-sheathed cables are to be used. Laying an e-cable directly in the cross-laminated timber is not recommended for reasons of possible cables being pulled behind

Partitioning systems for electric lines:

- Classified systems shall be used, and the maximum configuration density of proofs shall be met.
- In case of fire compartment forming walls, electric installations shall be laid in insulated front-wall constructions. In case of laying cables in solid timber components, compensation measures are required (such as encapsulation with non-combustible slabs or use of tested fire protection sockets).

8.9 Wood Facades

8.9.1 Heat and Moisture Protection

Wood facades should generally be designed with rear ventilation. Depending on the s_d values of the coating and the interior cladding, from a building physics point of view, these can also be ventilated and not rear-ventilated. Non-ventilated facades with an air layer are only recommended if the facade is not coated. Details can be found in [Guttman and Schober 2018].

Table 29: Evaluation matrix of the physical suitability of wooden facades for wooden exterior walls [source: Schober et al., 2018]

Bauweise	Fassadenkonstruktion	Fassadenart								
		Brett-Fassade z. B. Deckel- oder Stülp- schalung			Profilholz- Fassade z. B. Nut- u. Feder- schalung			Platten- Fassade z. B. 3-S Platte Sperrholz		
		Beschichtung								
		ohne	$s_d \leq 1$ m	$s_d > 1$ m	ohne	$s_d \leq 1$ m	$s_d > 1$ m	ohne	$s_d \leq 1$ m	$s_d > 1$ m
allg. Holzbauweise $s_d \leq 1$ m innen und/oder nicht allseitig luftdicht	hinterlüftet	+	+	+	+	+	+	+	+	+
	belüftet	o	o	o	-	-	-	-	-	-
	nicht hinterlüftet mit LS*	-	-	-	-	-	-	-	-	-
	nicht hinterlüftet ohne LS*	-	-	-	-	-	-	-	-	-
Holzrahmenbau & Holzmassivbau $s_d \geq 1$ m innen und allseitig luftdicht	hinterlüftet	+	+	+	+	+	+	+	+	+
	belüftet	+	+	+	+	+	+	+	+	o
	nicht hinterlüftet mit LS*	+	+	o	+	o	-	+	o	-
	nicht hinterlüftet ohne LS*	o	-	-	-	-	-	-	-	-

* LS = air layer

+ recommended o possible, but to be assessed on a case-by-case basis - critical

Table 30: Recommendations for the execution of wooden facades for wooden exterior walls [source: Schober et al, 2010]

Construction	Recommendations
Timber construction with a low s_d value inside ≤ 1.0 m and / or connections that are not flow-tight (airtight) on all sides	Wooden facade with ventilated air gap ≥ 3 cm
Timber frame construction with s_d value ≥ 1.0 m inside and flow-tight (airtight) connections on all sides	Wooden facade with ventilated or ventilated air gap at least 1 cm (guaranteed); construction practice ≥ 2 cm recommended. Non-ventilated facades with a closed air layer between the facade and the insulation material or wall former are possible if no coatings or at least diffusion-open coatings are used. Downward drainage is required.
Solid wood construction with a s_d value ≥ 1.0 m inside and a flat, flow-tight (airtight) solid wood construction (e.g. cross-laminated timber), all connections and openings are glued flow-tight	Wooden facade with ventilated or ventilated air gap at least 1 cm (guaranteed); construction practice ≥ 2 cm recommended. Non-ventilated facades with a closed air layer between the facade and the insulation material or wall former are possible if no coatings or at least diffusion-open coatings are used. Downward drainage is required.

8.9.2 Fire Protection

To prevent fire propagation of back-ventilated, ventilated or not back-ventilated facades, fire protection partitions shall be installed throughout the building story-wise across the whole facade width for buildings with four stories or more. Their position can be freely selected; however, arrangement in the area of story floors is most advisable.

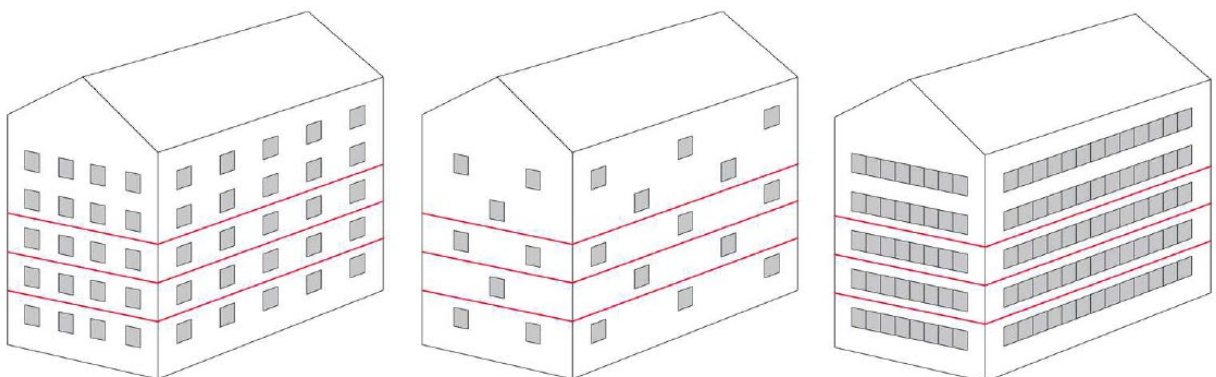

Figure 98: Examples of the arrangement of fire protection partitions with perforated facades or strips of ribbon windows (The fire protection barrier between the penultimate and last floor may be omitted based on the protection goal of ÖNORM B 3805-5)

Facades in buildings with more than three stories require positive proof according to ÖNORM B 3800-5.

Within the scope of research project, investigations into wood facades with various materials, back-ventilated cross sections, surface treatments and execution details of horizontal fire barriers were carried out [Schober und Matzinger 2006]. The results of investigations were the basis of standardized constructions without any proofs of [ÖNORM B 2332]. Results are summarized in Table 31.

Table 31: Compilation of the positively examined facade designs, source: [Schober und Matzinger 2006]

Construction Wall	Substructure Facade			Facade		
	Backventilation	Ventilation	Insulation	Facade / wood type	Orientation	Coating
Timber frame wall	30 mm	30 mm	with /without 30 mm mineral insulation	NF-paneling spruce / larch	horizontal / vertical	with / without surface coating
	30 mm with 30 mm counter battens					
	100 mm					
	100 mm with 30 mm counter battens					
Solid wood wall	30 mm	30 mm	with / without 30 mm mineral insulation	Three-layer board spruce / larch	horizontal / vertical	with / without surface coating
	30 mm with 30 mm counter battens					
	100 mm					
	100 mm with 30 mm counter battens					

8.9.2.1 Fire protection barriers

Fire protection barriers are required for ventilated facades to meet the protection goals. On the one hand, these close off the rear ventilation and prevent fire from spreading via the so-called “chimney effect” in the rear ventilation level. On the other hand, with combustible facades, they direct the flames away from the facade.

Table 32: Execution of fire protection barriers [Quelle: Schober & Matzinger, 2006]

Nr.	Material	Construction	Comments
1	non-flammable (min. A1)	Overhang ≥ 200 mm Sheet steel thickness ≥ 1.0 mm, no aluminum Fasteners steel, $e \geq 400$ mm; Longitudinal joints must ensure the function of the fire protection measure.	For all horizontal and vertical wooden facades as long as the strips $\geq 20/70$ mm and the joints ≤ 10 mm
2	Wood (mind. D) non- flammable, covered	Overhang ≥ 200 mm Wood thickness ≥ 20 mm Sheet steel thickness ≥ 0.5 mm Fasteners steel, $e \geq 625$ mm; Longitudinal joints must ensure the function of the fire protection measure.	
3	Three-layer board (min. D) ≥ 40 mm	Overhang ≥ 200 mm Fasteners steel, $e \geq 625$ mm Longitudinal joints must ensure the function of the fire protection measure.	
4	non-flammable (mind. A1)	Overhang ≥ 100 mm Sheet steel thickness ≥ 1.0 mm no aluminum Fasteners made of steel, $e \geq 400$ mm; Longitudinal joints must ensure the function of the fire protection measure.	Wooden facade (boards or panels) without joints
5	Wood (mind. D) non- flammable, covered	Overhang ≥ 100 mm Wood thickness ≥ 20 mm Sheet steel thickness ≥ 0.5 mm Fasteners steel, $e \geq 625$ mm; Longitudinal joints must ensure the function of the fire protection measure.	

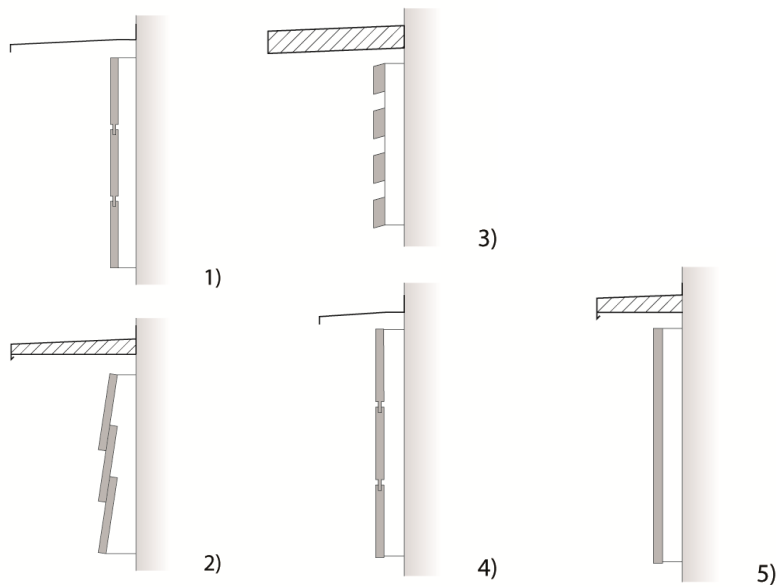

Figure 99: Execution of fire protection barriers (numbers correspond to Table 32)

Additional constructive measures are required in the area of the inside corners of the building, as the flame height is greater. Based on the investigations carried out, the following solutions were developed in order to meet the protection goals.

- Fire protection barriers for all wooden facades:
All types of wooden facades with or without windows in the area of the inner corner meet the requirements if a metal sheet at least 1 mm thick with a cantilever of at least 200 mm is used as a fire barrier.

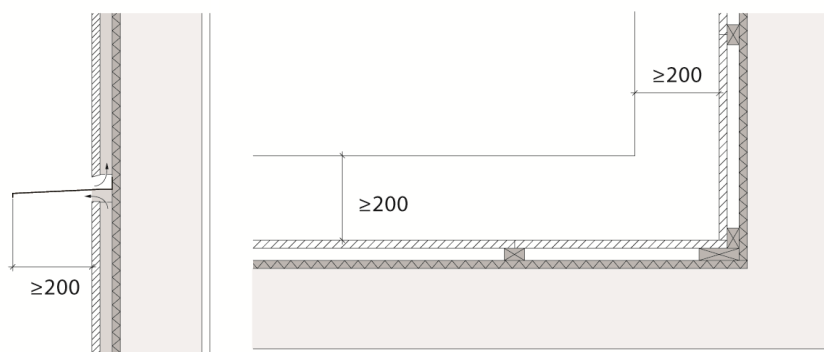

Figure 100: Variant 1 according to Table 32

- Fire protection barriers for wooden facades without joints, window spacing $\geq 1\text{m}$ to the inside corner:

If the windows have a minimum distance of more than 1 m to the inside corner and the wooden facade has no joints, the overhang can be reduced to 100 mm.

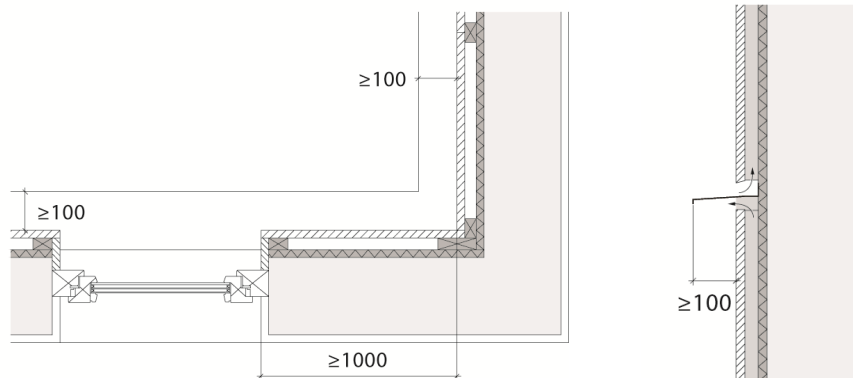

Figure 101: Variant 4 according to Table 32

- Fire protection barriers for wooden facades without joints, window distance $< 1\text{m}$ to the inside corner:

If the windows are less than 1 m away from the inside corner, a larger overhang of the fire barrier is required in the area of the inside corner.

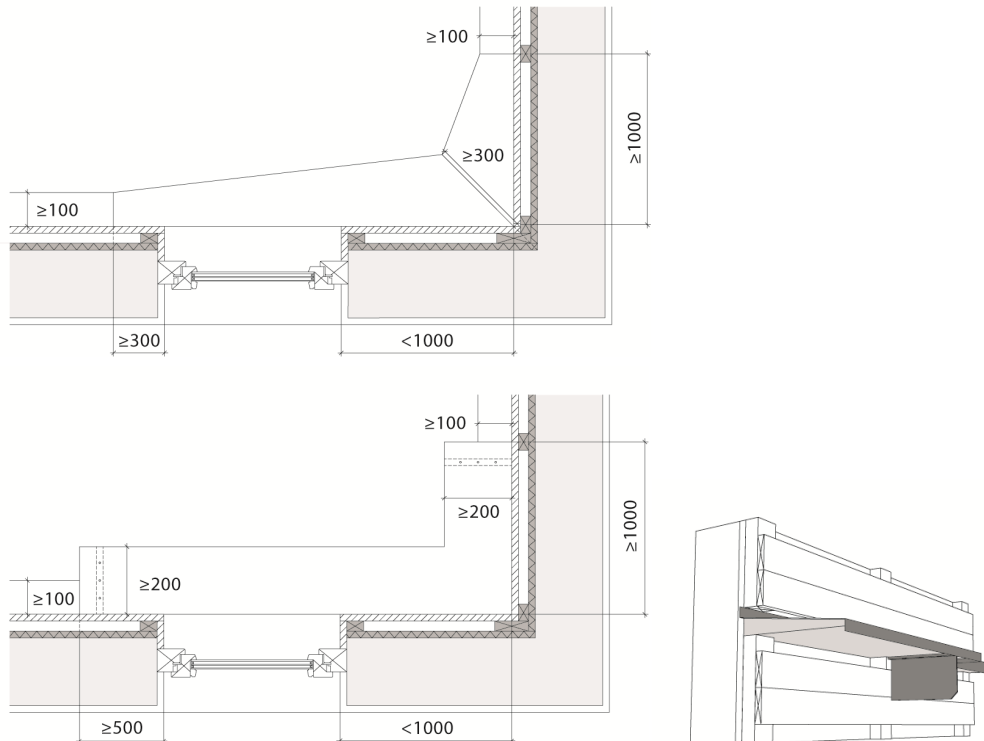

Figure 102: Variant 5 according to Table 32

In all cases, the fire protection seals must be tightly connected to the wall former. The clothing behind the rear ventilation cross-section is not to be combustible. In this case, windproof membranes can be regarded as harmless in terms of fire protection.

Wood facades:

- For buildings of building class GK 4 onwards, suspended back-ventilated, ventilated and not back-ventilated facades shall be partitioned story-wise. To this end, for wood facades, a 1 mm thick steel sheet with an overhang over the facade of at least 10 cm can be used. In internal corners, the overhang shall be at least 20 cm.
- Partitions shall be extended to the raw wall where it must be clad with a non-combustible material (e.g. gypsum fiberboard).
- Rules of constructive wood protection (e.g. no capillary joints) shall be complied with.
- The spray water impact of the facade due to partitioning shall be considered.
- For solid timber external walls, back-ventilated and ventilated wood facades (at least 1 cm air space) are possible from the view of building physics. Not back-ventilated facades with air space are possible only for uncoated wood facades.

8.10 Detailed solutions for plastered facades

In case of plastered facades executed with EPS insulation, the proof according to [ÖNORM B 3800-5] is regarded as fulfilled if a fire protection partition made of mineral wool MW-PT according to [ÖNORM B 6000] with a lateral overhang of 30 cm and a height of 20 cm, dowelled, is executed in the lintel area of windows and French windows. Figure 103 shows the arrangement of mineral wool bars for perforated facades and strips of ribbon windows.

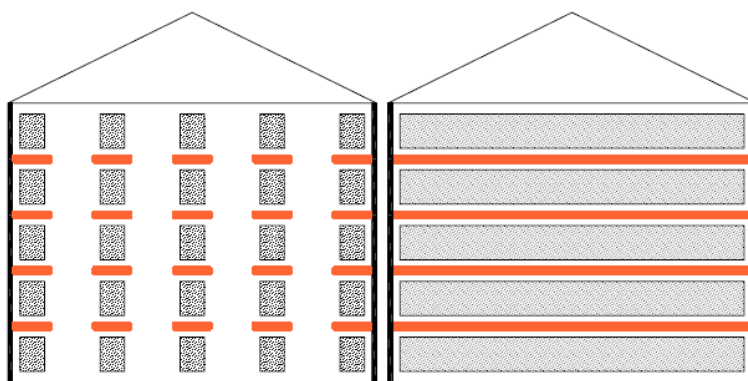

Figure 103: Example of the arrangements of fire protection partitions with perforated facades or strips of ribbon windows

Plastered facades:

- For buildings from building class GK 4 und EPS insulation material thicknesses >100 mm, story-wise partitions (e.g. stone wool bars with a height of 20 cm and a lateral overhang over openings of at least 30 cm) are required.

8.11 Balconies and Loggias

From the point of view of building physics and wood protection, penetrations through the ceilings as balcony or loggias are not recommended. Penetrations through the building envelope always represent a weak point. It must be ensured that they are connected airtight and windproof and that the thermal bridge of the fastening parts is taken into account. In the area of butt joints such as cross-laminated timber panels, cracks in squared timber, this can hardly be guaranteed. The balconies or loggias can be raised or suspended. The storage of the balcony slab must be acoustically decoupled.

Continuous balcony slabs should be avoided from the view of building physics as there may be uncontrolled air flows in the area of element joints or in the area of joints between individual non-glued boards or in case of cracks.

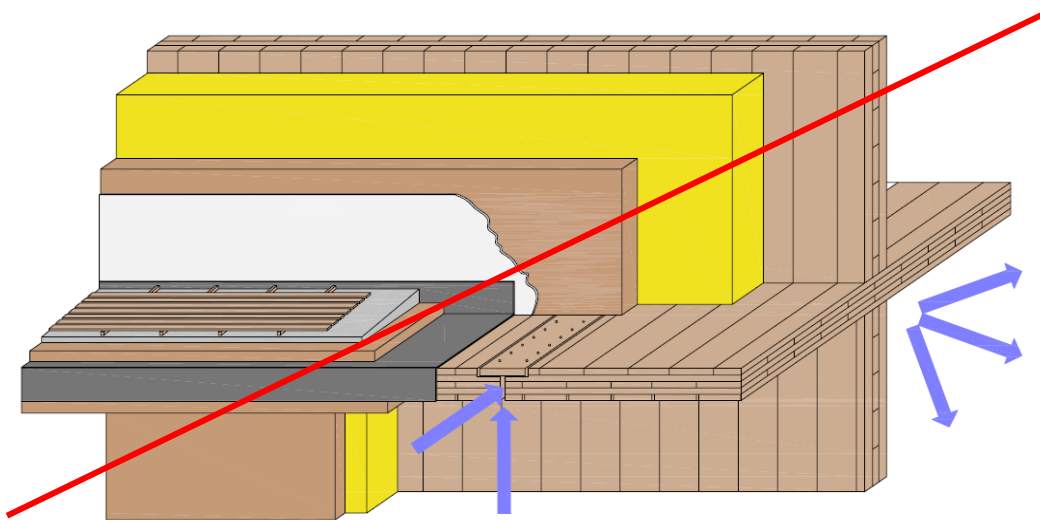

Figure 104: Schematic representation of continuous balcony slabs

Figure 105 shows a non-advisable execution of a balcony slab that is screwed on the story floor. In the connection area inside, elastic construction supports were placed between cross-laminated timber slabs, however, the reduced structure in the connection area does not meet requirements to impact sound protection due to the greatly reduced ballasting.

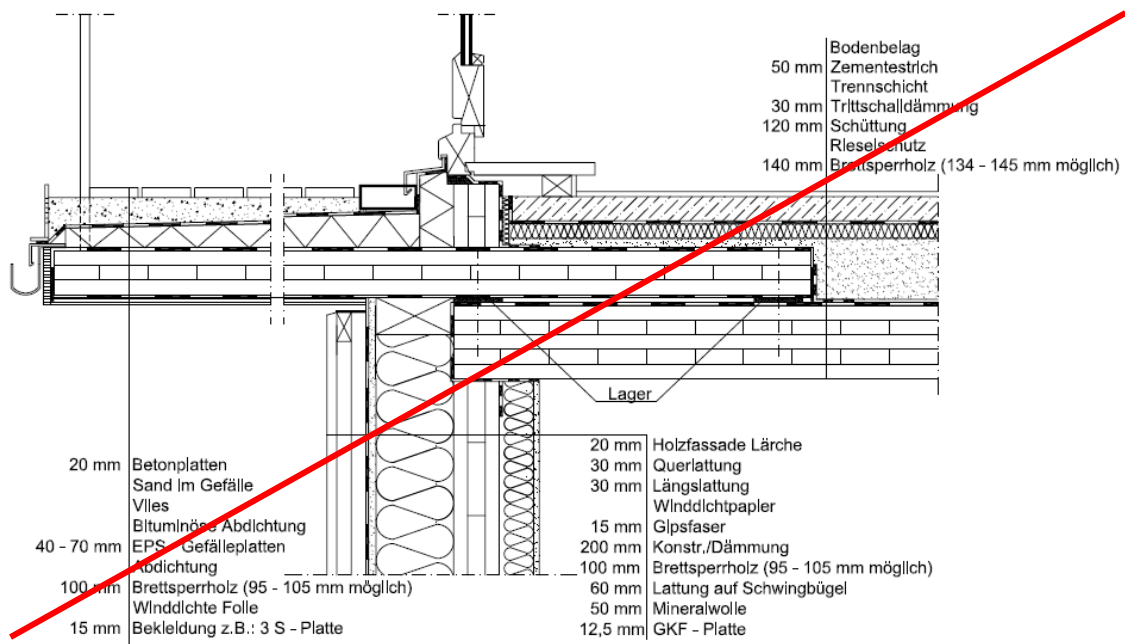

Figure 105: Insufficient execution of an overhanging balcony slab

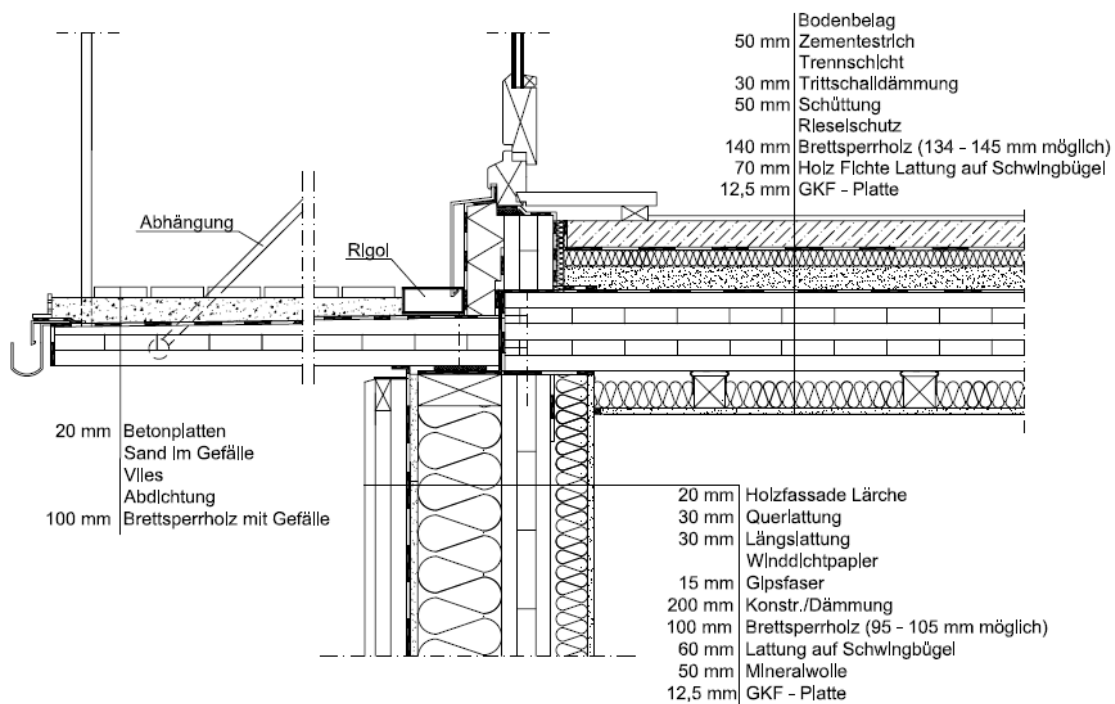

Figure 106: Recommended execution of an curtained and decoupled balcony slab

Figure 106 represents a detail with a suspended balcony as an example. Balconies can be executed by placing them on stands or by suspension. The bedding of the balcony slab shall be decoupled and the floor slab connection shall be made in flow-proof design.



Figure 107: Prefixed balcony construction, source: Stora Enso company

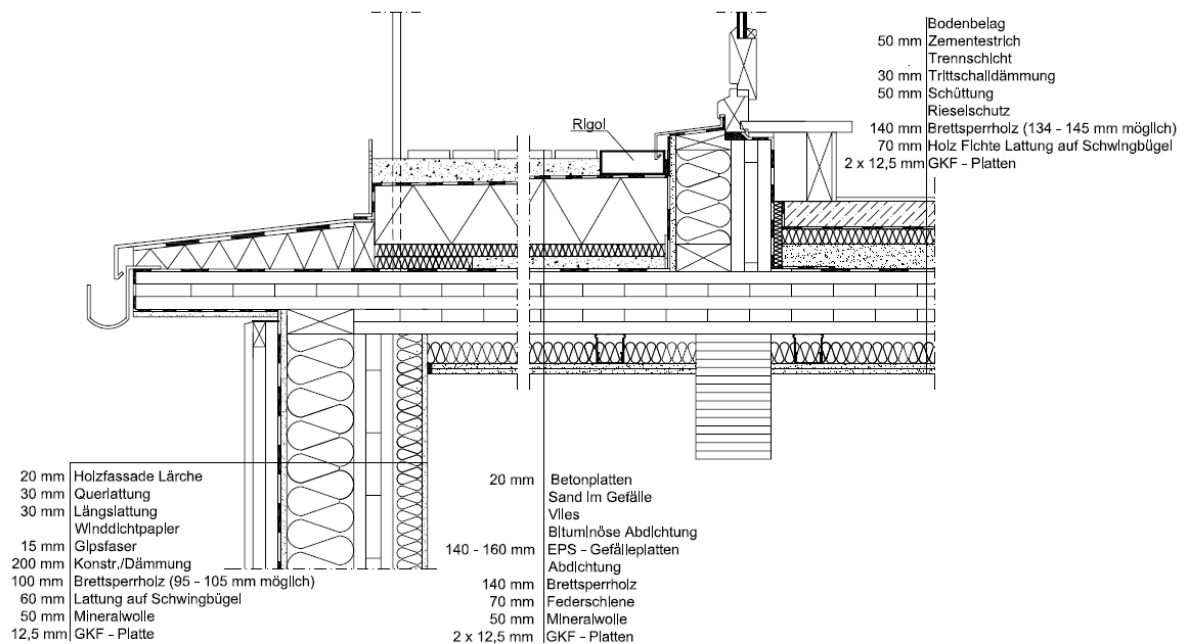

Figure 108: Terrace with recessed building shell

An exemplary execution of a terrace with a recessed story is shown in Figure 108. It is important to ensure that the overhung cross-laminated timber slab is flow-proof. The terrace structure shown meets the requirements to impact sound protection as was proved by measurements.

With this design, particular attention must be paid to proper sealing in the outer area of the cross-laminated timber panel and in the connection area to the recessed floor.

9 List of Figures

Figure 1:	Classification of timber constructions in residential construction.....	2
Figure 2:	Combination of cross-laminated timber floor and non-load bearing external wall in timber frame constructions.....	5
Figure 3:	Overview comparison of the planning and construction processes of timber construction and mineral construction	7
Figure 4:	Fire phases, source: [Schneider 2009]	10
Figure 5:	Representation of increased charring depth of another layer if the carbon layer of the top (2a) falls off, reduced combustion if a carbon layer of 25mm is formed (2b) and of constant burn-off without flaking off of the carbon layer (1), source: [ÖNORM EN 1995-1-2]	15
Figure 6:	Representation of charring depth as a function of time for $t_f > t_{ch}$ for gypsum boards type F and DF or GKF planked woods, source: [ÖNORM EN 1995-1-2].....	16
Figure 7:	Classification of material layers, source: [Schleifer 2009]	18
Figure 8:	Requirements for fire resistance and reaction-to-fire performance with buildings of building class 5, source: proholz/HFA.....	20
Figure 9:	Requirements for openings in roofs and external walls. Source: proholz/HFA	21
Figure 10:	Requirements for fire compartments and external wall strips extending across the ceiling in buildings with a maximum of six floors above ground (not residential buildings). Source: proholz/HFA.....	22
Figure 11:	Requirements for fire compartments and cross-ceiling external wall strips for GK 5 with more than six floors above ground (not residential buildings).....	22
Figure 12:	Requirements for GK 4 wooden facades of free-standing buildings that are accessible from the outside on at least three sides for firefighting. Source: proholz/HFA.....	23
Figure 13:	Relevant frequency ranges in building acoustics	28
Figure 14:	Curves of equal volume [Fasold et al. 2003].....	28
Figure 15:	Level doubling results in a 3dB increase of the total sound level	29
Figure 16:	From R to R_w - process of single number evaluation of the sound reduction index [Riccabona et al. 2010].....	30
Figure 17:	Evaluated building caustic parameters airborne sound, their application and standardization	32
Figure 18:	Characteristic portions of airborne sound insulation of single-leaf components	32
Figure 19:	Coincidence	33
Figure 20:	Sound reduction index of double-leaf components	34
Figure 21:	Calculated sound insulation index of jointless solid timber slabs depending on their thicknesses, source: [Bednar et al. 2000]	35

Figure 22: Evaluated building caustic parameters, impact sound, their application and standardization	36
Figure 23: Reduction of impact sound	37
Figure 24: Airborne sound and impact sound transmission routes between neighboring rooms	39
Figure 25: Comparison of required thicknesses of various construction materials for achieving an area thermal resistance of 2 m ² K/W	44
Figure 26: Development of heat protection of wood panel, single-leaf brick and sand-lime brick external walls, source: [Tichelmann 2007]	45
Figure 27: Passive house objects, classified according to their constructions, source: [Passivhaus]	46
Figure 28: U values of a 8cm thick cross-laminated timber wall (λ : 0.13 W/m ² K) as a function of thickness and heat conductivity of additional insulation	46
Figure 29: Dependence of absolute humidity and water vapor partial pressure on temperature and relative humidity	51
Figure 30: Pressure difference due to thermal in an 8m high room at the Klagenfurt site with an inside temperature of 24 ± 2 °C	52
Figure 31: Specific water vapor flow in g/m·h as a function of gap height, source: [Hauser und Maas 1992]	53
Figure 32: Heat and moisture leakages, source: [Künzel 2011]	53
Figure 33: Impact of joint design on airborne sound insulation for a 160mm thick cross-laminated timber floor, butt joint open $R_w = 30$ dB; butt joint sealed $R_w = 45$ dB, source: [Holtz et al. 2002]	56
Figure 34: Space of the partition wall filled up with mineral wool (gypsum plasterboard for sound protection reasons)	66
Figure 35: Stone wool and inadmissible continuous air layer between partition walls	66
Figure 36: Impact of non-bonded granular material on weighted standard impact sound insulation $L_{n,w}$, source: [Ferk 2006]	72
Figure 37: Laying of electric cables is to be executed in an airtight way for visible cross-laminated timber floors	72
Figure 38: Schematic represented of the mounting of a decoupled suspension, source: [Holtz et al. 1999b]	73
Figure 39: Mounting with decoupled suspension of whip arm, source: Knauf company	73
Figure 40: left: whip arm with elastic decoupling, right: spring strip	73
Figure 41: Floor system with whip arm and GKF with good sound protection properties, source: Knauf company	74
Figure 42: Sound transmission with continuous floors	74
Figure 43: Continuous floors, if used with partition walls, need a suspension in order to prevent sound longitudinal conduction	75
Figure 44: Faulty installation of screed film created a direct connection between screed and raw floor	75

Figure 45: Incorrect execution: intersection of pipelines	75
Figure 46: Vapor retarder (bituminous sealing) on a flat roof as a required weather protection	79
Figure 47: Standard base detail	81
Figure 48: Base detail with minimum heights:	82
Figure 49: Detail of terrace connection.....	82
Figure 50: Support detail of an internal wall	83
Figure 51: Window sill connection with sufficiently high window sill connection profile with at least 5° window sill inclination and a minimum facade overhang of 40 mm, source: [Österreichische Arbeitsgemeinschaft Fensterbank]	85
Figure 52: Windows sill installation on second sealing plane, bonded with adhesive beading. The resulting void spaces are admissible. The insulation material wedges / facade bead is connected with the window sill connection profile by means of a sealing tape (red circle Source: [Österreichische Arbeitsgemeinschaft Fensterbank]	85
Figure 53: Horizontal joint under window sill towards facade surface with permeable sealing tape. Can also be executed in open form Source: [Österreichische Arbeitsgemeinschaft Fensterbank]	85
Figure 54: Example of a door connection for a French balcony	86
Figure 55: External wall corner: on the left, prefabrication (view); on the right, assembly (top view)	87
Figure 56: Exemplary execution of external wall corner	87
Figure 57: Exemplary execution of outer wall corner with installation level	88
Figure 58: Remaining wood cross section in the joint area of wetted boards	89
Figure 59: Remaining wood cross section in the joint area of rebated connections	89
Figure 60: Element butt joint design of cross-laminated timber elements for verifying the integrity and heat insulation function, source: [ÖNORM B 1995-1-2]	90
Figure 61: Connection details of a clad cross-laminated timber wall following [ÖNORM B 2320]	91
Figure 62: Connection detail of a clad cross-laminated timber wall to a floor construction following [ÖNORM B 2320]	91
Figure 63: Connection detail of a clad cross-laminated timber wall to a suspended floor construction following [ÖNORM B 2320]	91
Figure 64: Sylomer supports in the padding support area for decoupling	95
Figure 65: Inadmissible fastening of the elastic padding support using nails	95
Figure 66: Lead edge insulating strip to the raw floor	96
Figure 67: Coupling by filler due to screed insulating strips cut too short.....	96
Figure 68: Joint filler between wall and floor tiles	96
Figure 69: Connection of a fire compartment forming partition wall to an external wall. The external wall should have a fire resistance of 90 minutes at a point of 0.5 m away from the axis of the fire compartment forming wall	99

Figure 70: Exemplary connection of a fire compartment forming separation floor to the external wall (120cm external wall strip).....	101
Figure 71: Exemplary connection of a fire compartment forming separation floor to the external wall (80cm overhang).....	101
Figure 72: Exemplary connection of a fire compartment forming partition wall to a separating floor.....	103
Figure 73: Exemplary connection of a fire compartment forming partition wall to a tin roof.....	105
Figure 74: Exemplary connection of a fire compartment forming wall to a flat sloping roof with on-roof insulation.....	105
Figure 75: Schematic diagram of shaft type A, source: [Installationen-Richtlinie MA 37]	107
Figure 76: Exemplary design of a penetration of shaft type A for a solid timber floor	108
Figure 77: Schematic diagram of shaft type B, source: [Installationen-Richtlinie MA 37]	109
Figure 78: Exemplary design of horizontal partitioning in the area of a solid timber floor (shaft type B)	109
Figure 79: Incorrect execution: Due to a later extension of the shaft, non-combustible cladding of the wooden beam inside the shaft is not possible	110
Figure 80: Installation of a reveal covering not over its entire surface	111
Figure 81: Sound protection decoupling of pipes	111
Figure 82: Survey of partitioning systems for water and air-bearing lines and electric cables	113
Figure 83: Installation of the soft partition in a sample body (left: reveal covering center: Installation of the mineral fiberboards that is coated on its edges, right: Overcoating of surface beyond the edge of 20mm).....	114
Figure 84: Application of coating on reveal and reveal coating, source: Würth company.....	114
Figure 85: Cut to size of mineral fiberboard and coating of boards and reveal, source: Würth company	114
Figure 86: Sealing of cable penetrations and finished partitioning, source: Würth company.....	115
Figure 87: Installation of a fire protection collar directly in an unclad solid timber wall; left: Filling up the annular gap, center: intumescent fire protection compound, right: fastening of the fire protection collar	116
Figure 88: Fastening of a fire protection collar in a soft partition is admissible only if it is led through, source: bip company	117
Figure 89: View of a fire protection closure based on intumescent materials with closing element (FLI-VE	119
Figure 90: Insulation of the annular gap between ventilation pipe and wooden component with stone wool (center), application of an intumescent fire protection compound with a depth of about 15mm (right)	119

Figure 91: Rigid fastening of the ventilation pipe in the wood floor (left), fire protection closure based on intumescent materials with closing element FLI-VE (center), installation in sample body (right).....	119
Figure 92: Installation of a fire protection flap in a fire compartment forming partition wall.....	120
Figure 93: Installation of a fire protection flap in a shaft wall.....	120
Figure 94: Examples of partitions by means of fire protection foam for electric cables, source: bip company	121
Figure 95: Fire protection foam used as a means of partitioning off cables and pipes, source: Hilti company	122
Figure 96: Examples of installation of wall sockets, source: Air Fire Tech company.....	122
Figure 97: Hollow wall box with intumescent of the Kaiser company, before and after fire exposure (source: https://assets.kaiser-elektro.de/media/11/113/KAISER_Brandschutz_Broschuere_2018_DE_web.pdf).....	122
Figure 98: Examples of the arrangement of fire protection partitions with perforated facades or strips of ribbon windows (The fire protection barrier between the penultimate and last floor may be omitted based on the protection goal of ÖNORM B 3805-5).....	125
Figure 99: Execution of fire protection barriers (numbers correspond to Table 32).....	128
Figure 100: Variant 1 according to Table 32.....	128
Figure 101: Variant 4 according to Table 32.....	129
Figure 102: Variant 5 according to Table 32.....	129
Figure 103: Example of the arrangements of fire protection partitions with perforated facades or strips of ribbon windows.....	130
Figure 104: Schematic representation of continuous balcony slabs	131
Figure 105: Insufficient execution of an overhanging balcony slab	132
Figure 106: Recommended execution of an curtained and decoupled balcony slab.....	132
Figure 107: Prefixed balcony construction, source: Stora Enso company	133
Figure 108: Terrace with recessed building shell.....	133

10 List of Tables

Table 1:	Recommended values of free span widths for timber floors	4
Table 2:	Classification of Flammability according to ÖNORM B 3800-1 (redacted on 01.07.2004)	11
Table 3:	Classification of fire protection classes according to ÖNORM EN 13501-1	11
Table 4:	Reaction-to-fire performance of selected construction materials	12
Table 5:	Designations for fire resistance according to ÖNORM EN 13501-2 (abstract), figures taken from [Östman et al 2010]	13
Table 6:	Examples of designations for fire resistance	14
Table 7:	Rated values of mass burning rates β_0 for cross-laminated timber elements depending on bonding of individual plies	15
Table 8:	Requirements to the reaction-to-fire performance of facades according to [OIB Guideline 2 2015]	24
Table 9:	Requirements for fire-retarding sealings in stories above ground according to [OIB Guideline 2 2015].....	25
Table 10:	Requirements of the weighted resulting building sound insulation index $R'_{res,w}$ for residential buildings, residential establishments, hotels, schools, kindergartens, hospitals, spa buildings and the like according to [OIB Guideline 5 2015]	41
Table 11:	Requirements for the weighted standard sound level difference $D_{nt,w}$ inside buildings according to [OIB Guideline 5 2015]	41
Table 12:	Requirements for the weighted standard impact sound level $L'_{nt,w}$ in buildings according to OIB Guideline 5 [OIB Guideline 5 2015]	42
Table 13:	Heat conductivity of selected construction materials, Sources: [ÖNORM EN 12524] ¹⁾ and proposal [ÖNORM B 8110-7] ²⁾	44
Table 14:	Requirements to heat-transferring components, extract from OIB Guideline 6 [OIB Richtlinie 6 2015]	48
Table 15:	Example for relative humidity	50
Table 16:	Survey of requirements to individual component layers	56
Table 17:	External wall with external wall thermal insulation composite system (WDVS) with and without installation level (maximum component height 3 m).....	57
Table 18:	External wall with back-ventilated facade without and with dry lining (maximum component height 3 m).....	58
Table 19:	Reference values for the improvement of the airborne sound insulation index of a non-clad cross-laminated timber external wall with a WDVS	60
Table 20:	Internal wall with and without gypsum plasterboard (maximum component height 3 m)	61
Table 21:	Partition wall, single leaf (maximum component height 3 m).....	63
Table 22:	Partition wall, double leaf (maximum component height 3 m)	64

Table 23: Reference values for improving the sound insulation index for an unclad double-leaf cross-laminated timber wall with insulated space (60 mm mineral wool).....	65
Table 24: Example of a fire compartment forming wall (maximum component height 3 m).....	67
Table 25: Example of a separating floor (maximum span 5 m).....	70
Table 26: Examples of flat roofs, without and with suspended bottom view for a span of 5 m.....	77
Table 27: Heat insulation materials for over-rafter insulation [Reyer et al. 2002]	78
Table 28: Construction principles with regard to the necessity of elastic supports.....	93
Table 29: Evaluation matrix of the physical suitability of wooden facades for wooden exterior walls [source: Schober et al., 2018].....	124
Table 30: Recommendations for the execution of wooden facades for wooden exterior walls [source: Schober et al, 2010].....	125
Table 31: Compilation of the positively examined facade designs, source: [Schober und Matzinger 2006]	126
Table 32: Execution of fire protection barriers [Quelle: Schober & Matzinger, 2006]	127

11 Table of References

- Adnot, J.; Waide, P. (2003): *Energy Efficiency and Certification of Central Air Conditioners. Final Report Volume I-III.*
- Adriaans, R. (2004): *Dämmen und Dichten mit System. Flachdächer auf Holzkonstruktionen.* In: *Holzbau - die neue quadriga*, H. 5, S. 23–27.
- Bednar, T.; Vodicka, M.; Dreyer, J. (2000): *Entwicklung im mehrgeschossigen Holzbau am Beispiel des Schallschutzes der Trenndecken: ÖPG 2000.*
- Bundesverband der Gipsindustrie e.V. Industriegruppe Gipsplatten (Hg.) (2004): *Gipsplattenkonstruktionen Fugen und Anschlüsse.*
- Cremer, L.; Heckl, M. (1995): *Körperschall. Physikalische Grundlagen und technische Anwendungen.* 2., völlig neubearbeitete Auflage: Springer-Verlag GmbH & Co. KG.
- Dolezal, Franz; Bednar, Thomas; Teibinger, Martin (2008): Flankenübertragung bei Massivholzkonstruktionen, Teil 1. Verbesserung der Flankendämmung durch Einbau elastischer Zwischenschichten und Verifizierung der Anwendbarkeit von EN 12354. In: *Bauphysik* 30 (3), S. 143–151.
- Dolezal, Franz; Bednar, Thomas; Teibinger, Martin (2008): Flankenübertragung bei Massivholzkonstruktionen, Teil 2. Einfluss von Befestigungsmitteln auf die Verbesserung durch den Einbau elastischer Zwischenschichten. In: *Bauphysik* 30 (5), S. 314–319.
- Fasold, W.; Veres, E. (2003): *Schallschutz und Raumakustik in der Praxis. Planungsbeispiele und konstruktive Lösungen.* 2. Aufl. Berlin: Huss-Medien Verl. Bauwesen.
- Ferk, H. (2006): *Hör' mal, wer da hämmert. Schallschutz von Massivholzdecken - Anforderungen und Lösungen. Massivholzdecken können bei richtiger Konstruktion guten Schallschutz bieten.:* Holz_Haus_Tage 2006. Fachtagung für innovative Holzhausbauer. Gmunden, S. 28–43.
- Fischer, H.-M.; Freymuth, H.; Häupl, P.; Homann, M.; Jenisch, R.; Richter, E.; Stohrer, M. (2008): *Lehrbuch der Bauphysik. Schall - Wärme - Feuchte - Licht - Brand - Klima.* (Springer-11774 /Dig. Serial]). Online verfügbar unter <http://dx.doi.org/10.1007/978-3-8348-9467-0>, zuletzt geprüft am 19.04.2021.
- Frangi, A.; Fontana, M.; Knoblauch, M. (2008): *Fire Behaviour of Cross-Laminated Solid Timber Panels.* Herausgegeben von ETH Zürich. Institute fo Structural Engineering.
- Frühwald, A.; Pohlmann, C.; Wegener, G. September (2001): *Holz Rohstoff der Zukunft. nachhaltig verfügbar und umweltgerecht.* Herausgegeben von Deutsche Gesellschaft für Holzforschung und Holzabsatzfonds. München.
- Guttmann, E.; Schober Klaus Peter (2010): *Fassaden aus Holz: proHolz Österreich.*
- Hauser, G.; Maas, A. (1992): *Auswirkungen von Fugen und Fehlstellen in Dampfsperren und Wärmedämmschichten.* In: *Deutsche Bauzeitschrift*, Jg. 24, H. 1, S. 91–100.
- Holtz, F.; Hessinger, J.; Buschbacher, H. P.; Rabold, A. (1999a): *Schalldämmende Holzbalken- und Brettstapeldecken. Informationsdienst Holz.* In: *holzbau handbuch* Reihe 3 Teil 3 Folge 3.
- Holtz, F.; Hessinger, J.; Buschbacher, H. P.; Rabold, A. (1999b): *Schalldämmende Holzbalken- und Brettstapeldecken. Informationsdienst Holz.* In: *holzbau handbuch* Reihe 3 Teil 3 Folge 3.

- Holtz, F.; Hessinger, J.; Buschbacher, H. P.; Rabold, A. (2004): *Entwicklung eines anwenderbezogenen Berechnungsverfahrens zur Prognose der Schalldämmung von Holzdecken am Bau. Anhang mit Messergebnissen*. Herausgegeben von Labor für Schall- und Wärmemesstechnik. Labor für Schall- und Wärmemesstechnik. Rosenheim.
- Holtz, F.; Rabold A.; Hessinger J.; Buschbacher H.P.; Oechsle O.; Lagally Th. (2002): *Schalltechnische Kennwerte von Massivholzbauteilen. Bestandsaufnahme und Analyse. Endbericht von 18.03.2002*.
- Installationen-Richtlinie MA 37: *Brandschutztechnische Anforderungen bei Leitungsdurchführungen gemäß Techniknovelle 2007. MA 37 – B/27690/2008*.
- Jörg, M. (2010): *proHolz Edition 09. Holz und Klimaschutz*. Herausgegeben von proHolz Österreich. Wien.
- Köhnke, E. (2012): *Auswirkungen von Einbaufehlern auf den Schallschutz. Veranstaltung vom 8.-9. März 2012, aus der Reihe "3. Internationaler Holz[Bau]Physik-Kongress"*. Leipzig.
- Künzel, H. M. (2011): *Trocknungsreserven bemessen! Einfluss des Feuchteintrages aus Dampfkongvektion. Veranstaltung vom 10.02.2011, aus der Reihe "2. internationaler Holz[Bau]Physik-Kongress"*. Leipzig.
- Lang, J. (2004): *Luft- und Trittschallschutz von Holzdecken und die Verbesserung des Trittschallschutzes durch Fußböden auf Holzdecken*. In: wksb, Ausgabe 52, S. 7–14.
- Maack, J. (2008): *Schallschutz von geneigten Dächern und Dachflächenfenstern. Abschlussbericht Forschungsarbeit*. Herausgegeben von Fraunhofer IRB Verlag. ITA Ingenieurgesellschaft für technische Akustik MBH Beratende Ingenieure VBI. Stuttgart.
- Müller, G.; Möser, M. (2004): *Taschenbuch der technischen Akustik*. 3., erw. und überarb. Aufl. Berlin: Springer (Engineering online library).
- Nusser, B. (2012): *Flachgeneigte hölzerne Dachkonstruktionen. Systemanalysen und neue Ansätze zur Planung hygrisch robuster flachgeneigter hölzerner Dachkonstruktionen unter Beachtung konvektiver Feuchteinträge und temporärer Beschattungssituationen. Dissertation*. TU Wien, Forschungsbereich für Bauphysik und Schallschutz, Institut für Hochbau und Technologie.
- Öhrström, E.; Skanberg, A. (2004): *Sleep disturbances from road traffic and ventilation noise—laboratory and field experiments*. In: Journal of Sound and Vibration, Jg. 271, Ausgabe 1-2, 22 March 2004, S. 279–296.
- OIB (Hg.) (2011): *OIB Richtlinie 5. Schallschutz*. Online verfügbar unter <http://www.oib.or.at>, zuletzt geprüft am 19.04.2021.
- OIB (Hg.) (2011): *OIB Richtlinie 2. Brandschutz*. Online verfügbar unter <http://www.oib.or.at>, zuletzt geprüft am 19.04.2021.
- OIB (Hg.) (2001): *OIB Richtlinie 3 Hygiene, Gesundheit und Umweltschutz*. Online verfügbar unter <http://www.oib.or.at>, zuletzt geprüft am 19.04.2021.
- OIB (Hg.) (2011): *OIB Richtlinie 6. Energieeinsparung und Wärmeschutz*. Online verfügbar unter <http://www.oib.or.at>, zuletzt geprüft am 19.04.2021.
- Österreichische Arbeitsgemeinschaft Fensterbank (Hg.): *Richtlinie für den Einbau von Fensterbänken bei WDVS- und Putzfassaden*. (1/2012). Online verfügbar unter https://www.holzforchung.at/fileadmin/user_upload/Downloads/Broschueren/gratisdownloads/FB_Richtlinie_2020_4_Auflage.pdf, zuletzt geprüft am 20.04.2021.
- Östman, B.; et al (2010): *Fire safety in timber buildings. Technical guideline for Europe*. Herausgegeben von SP Trätek. Stockholm.

- Östman, B.; Jarnerö, K.; Sjökvist, L.-G.; Larsson, K.; Tillberg, K. (2008): *Acoustics in wooden buildings. State of the art 2008. SP Report 2008:16*. Stockholm.
- Passivhaus. Online verfügbar unter <http://www.passivhausdatenbank.at/statistics.php#statistik6>, zuletzt geprüft am 19.04.2021.
- Polleres S. (2010): *Sockel quo vadis. Freiland- und Laboruntersuchungen der Holzforschung Austria zeigen Probleme und Lösungen für den Holzbau*: Holzbau, 01/2010, S. 21–24.
- Polleres S.; Schober K. P. (2004): *Bauteilkatalog für den Holzbau. Endbericht*. Herausgegeben von Holzforschung Austria. Wien.
- Polleres S.; Schober K. P. (2009a): *Holzhausbau - Architektur versus Technik. Teil 2 Fensteranschluss. FFG Endbericht*. Holzforschung Austria. Wien.
- Polleres S.; Schober K. P. (2009b): *Holzhausbau - Architektur versus Technik. Teil 1: Sockelanschluss. FFG Endbericht*. Holzforschung Austria. Wien.
- Reyer, E.; Schild, K.; Völkner, S. (2002): *Wärmedämmstoffe*. In: Cziesielski, Erich (Hg.): *Bauphysik-Kalender 2002*: Ernst & Sohn, S. 197–257.
- Rijal, H. e. a. (2008): *Development of an adaptive window-opening algorithm to predict the thermal comfort, energy use and overheating in buildings*: Journal of Building Performance Simulation, Vol. 1, No.1 March 2008, S. 17–30.
- Schleifer, V. (2009): *Zum Verhalten von raumabschließenden mehrschichtigen Holzbauteilen im Brandfall. Dissertation. Betreut von M. Fontana, A. Frangi und J. König*. Zürich. Eidgenössische Technische Hochschule Zürich, Institut für Baustatik und Konstruktion.
- Schmid, J.; König, J.; Köhler, J.: *Fire-exposed cross-laminated-timber - Modelling and tests: WCTE 2010 (World Conference Timber Engineering)*.
- Schnieders, J. (2003): *Ein vereinfachtes Verfahren zur Abschätzung des sommerlichen Luftwechsels*: Protokollband 22 Lüftungsstrategien im Sommer, Arbeitskreis kostengünstige Passivhäuser - Phase III, Passivhausinstitut, Darmstadt 2003.
- Schober, K. P.; et.al (2010): *Fassaden aus Holz*. Wien: proHolz Österreich.
- Schober, K. P.; Matzinger, I. (2006): *Brandschutztechnische Ausführung von Holzfassaden. Zusammenfassung und Erkenntnisse für Gebäudeklasse 4 und 5*. Herausgegeben von Pro Holz Austria. Wien.
- Schoenwald, S.; Heiko, M. J.; Gerresten, E. (2004): *Aspects of the measurement of Kij at junctions of lightweight assembled structures*. In: DEGA (Hg.): DAGA 2004. Straßburg.
- Studiengemeinschaft Holzleimbau e.V. (Hg.) (2012): *Wichtige Hinweise für den Umgang mit Brettsperrholz (BSP)*. Wuppertal. Online verfügbar unter http://www.brettsperrholz.org/publish/binarydata/Brettsperrholz/downloads/stqhb_brettsperrholz-hinweise.pdf, zuletzt geprüft am 19.04.2021.
- Teibinger, M.: *Brandverhalten von Holz- und Holzwerkstoffen. Anforderungen - Entwicklungen*. Holzforschung Austria. Wien.
- Teibinger, M. (2011): *Brandschutzvorschriften in Österreich Anforderungen nach OIB-Richtlinie 2*. Herausgegeben von Pro Holz Austria. Wien.
- Teibinger, M.; Charwat-Pessler, J.; Matzinger, I.: *Bemessung von Holzbauteilen im Brandfall nach ÖNORM EN 1995-1-2*. Holzforschung Austria. Wien.

- Teibinger, M.; Dolezal, F.; Matzinger, I. (2009): *Deckenkonstruktionen für den mehrgeschoßigen Holzbau. Schall- und Brandschutz*. Herausgegeben von Holzforschung Austria. Wien.
- Teibinger, M.; Matzinger, I. (2008): *Urbanes Bauen in Holz- und Holzgemischbauweise. Untersuchungen zum Brandverhalten von Wand-Deckenanschlüssen*. Holzforschung Austria. Wien.
- Teibinger, M.; Matzinger, I. (2010): *Grundlagen zur Bewertung des Feuerwiderstandes von Holzkonstruktionen. Endbericht*. Holzforschung Austria. Wien.
- Teibinger, M.; Matzinger, I. (2012): *Brandabschottung im Holzbau. Planungsbroschüre*. Holzforschung AUSTRIA. Wien
- Tichelmann, K. e. a. (2007): *Schwerpunkt Bauphysikalische Eigenschaften von Leichtbauweisen. Eigenschaften und Potentiale des Leichtbaus*. Herausgegeben von BAU.GENIAL. Online verfügbar unter https://baugenial.at/wp-content/uploads/2019/03/BAU.GENIAL_Schwerpunkt-Bauphysik.pdf, zuletzt geprüft am 19.04.2021.
- Varga, M.; Pagliano, L. (Hg.) (2006): *Reducing cooling energy demand in service buildings*.
- Wallner-Novak, M.; Koppelhuber, J.; Pock, K. (2012): *Brettsperrholz - Leitfaden - Bemessung und Konstruktion nach Eurocode*. Herausgegeben von Manuskript der Verfasser. Graz.
- Weber, L.; Scholl, W. (2000): *Stoßstellendämmung von Leichtbauwänden*. In: DEGA (Hg.): DAGA 2000. Oldenburg.

12 List of Standards

- ÖNORM B 1995-1-2; 01.09.2011: *Eurocode 5: Entwurf, Berechnung und Bemessung von Holzbauten - Teil 1-2: Allgemeine Regeln - Bemessung für den Brandfall - Nationale Festlegungen zu ÖNORM EN 1995-1-2, nationale Erläuterungen und nationale Ergänzungen.* Österreichisches Normungsinstitut.
- ÖNORM B 2320, 2010-07-15: *Wohnhäuser aus Holz - Technische Anforderungen.* Österreichisches Normungsinstitut
- ÖNORM B 2330, 2007 05 01: *Brandschutztechnische Ausführung von mehrgeschoßigen Holz- und Holzfertighäusern - Anforderungen und Ausführungsbeispiele.* Österreichisches Normungsinstitut.
- ÖNORM B 2332, 2007-05-01: *Brandschutztechnische Ausführung von Fassaden aus Holz und Holzwerkstoffen in den Gebäudeklassen 4 und 5 - Anforderungen und Ausführungsbeispiele.* Österreichisches Normungsinstitut.
- ÖNORM B 3410, 2006 09 01: *Gipsplatten für Trockenbausysteme (Gipskartonplatten) - Arten, Anforderungen und Prüfungen.* Österreichisches Normungsinstitut.
- ÖNORM B 3800-1, 1988 12 01 Zurückziehung: 2004 01 01: *Brandverhalten von Baustoffen und Bauteilen; Baustoffe: Anforderungen und Prüfungen.* Österreichisches Normungsinstitut.
- ÖNORM B 3800-5, Mai 2004: *Brandverhalten von Baustoffen und Bauteilen - Teil 5: Brandverhalten von Fassaden - Anforderungen, Prüfungen und Beurteilungen.* Österreichisches Normungsinstitut.
- ÖNORM B 3802-2, 1998 04 01: *Holzschutz im Hochbau - Chemischer Schutz des Holzes.* Österreichisches Normungsinstitut.
- ÖNORM B 3804, 2002 03 01: *Holzschutz im Hochbau - Gebäude, errichtet aus vorgefertigten Holzbauteilen - Voraussetzung für die Reduktion von chemischen Holzschutzmaßnahmen.* Österreichisches Normungsinstitut.
- ÖNORM B 5300, 2007-11-01: *Fenster - Anforderungen - Ergänzungen zur ÖNORM EN 14351-1.* Österreichisches Normungsinstitut.
- ÖNORM B 5320, 206-09-01: *Bauanschlussfuge für Fenster, Fenstertüren und Türen in Außenbauteilen - Grundlagen für Planung und Ausführung.* Österreichisches Normungsinstitut.
- ÖNORM B 5321, 2001 12 01: *Bauanschlussfuge für Fenster, Fenstertüren, Türen und Tore in Außenbauteilen - Prüfverfahren.* Österreichisches Normungsinstitut.
- ÖNORM B 6000, 2010-01-01: *Werkmäßig hergestellte Dämmstoffe für den Wärme- und/oder Schallschutz im Hochbau - Arten, Anwendung und Mindestanforderungen.* Österreichisches Normungsinstitut.
- ÖNORM B 8110-7, 2012-11-15: *Wärmeschutz im Hochbau - Teil 7: Tabellierte wärmeschutztechnische Bemessungswerte.* Österreichisches Normungsinstitut.
- ÖNORM B 8115-2, 2006 12 01: *Schallschutz und Raumakustik im Hochbau - Teil 2: Anforderungen an den Schallschutz.* Österreichisches Normungsinstitut.
- ÖNORM B 8115-5, April 2012: *Schallschutz und Raumakustik im Hochbau - Teil 5: Klassifizierung.* Österreichisches Normungsinstitut.

- ÖNORM EN 300, 2006 09 01: *Platten aus langen, flachen, ausgerichteten Spänen (OSB) - Definitionen, Klassifizierung und Anforderungen*. Österreichisches Normungsinstitut.
- ÖNORM EN 309, 2005 04 01: *Spanplatten - Definition und Klassifizierung*. Österreichisches Normungsinstitut.
- ÖNORM EN 338, 2009 12 01: *Bauholz für tragende Zwecke - Festigkeitsklassen*. Österreichisches Normungsinstitut.
- ÖNORM EN 520, 2010 07 01: *Gipsplatten - Begriffe, Anforderungen und Prüfverfahren*. Österreichisches Normungsinstitut.
- ÖNORM EN 1026, 2000-10-01: *Fenster und Türen - Luftdurchlässigkeit - Prüfverfahren*. Österreichisches Normungsinstitut.
- ONORM EN 1182, September 2010: *Prüfungen zum Brandverhalten von Bauprodukten - Nichtbrennbarkeitsprüfung (ISO 1182:2010)*. Österreichisches Normungsinstitut.
- ÖNORM EN 1366-3, 2009 05 01: *Feuerwiderstandsprüfungen für Installationen - Teil 3: Abschottungen*. Österreichisches Normungsinstitut.
- ÖNORM EN 1991-1-2, 2009 08 01: *Eurocode 1 - Einwirkungen auf Tragwerke - Teil 1-2: Allgemeine Einwirkungen - Brandeinwirkungen auf Tragwerke (konsolidierte Fassung)*. Österreichisches Normungsinstitut.
- ÖNORM EN 1995-1-2, 01.09.2011: *Eurocode 5: Bemessung und Konstruktion von Holzbauten Teil 1-2: Allgemeine Regeln - Tragwerksbemessung für den Brandfall (konsolidierte Fassung)*. Österreichisches Normungsinstitut.
- ÖNORM EN 12354-1, 2000 11 01: *Bauakustik - Berechnung der akustischen Eigenschaften von Gebäuden aus den Bauteileigenschaften - Teil 1: Luftschalldämmung zwischen Räumen*. Österreichisches Normungsinstitut.
- ÖNORM EN 12524, 2000-09-01: *Baustoffe und -produkte - Wärme- und feuchteschutztechnische Eigenschaften - Tabellierte Bemessungswerte*. Österreichisches Normungsinstitut.
- ÖNORM EN 13162, 2013 01 15: *Wärmedämmstoffe für Gebäude - Werkmäßig hergestellte Produkte aus Mineralwolle (MW) - Spezifikation*. Österreichisches Normungsinstitut.
- ÖNORM EN 13501-1, Mai 2007: *Klassifizierung von Bauprodukten und Bauarten zu ihrem Brandverhalten - Teil 1: Klassifizierung mit den Ergebnissen aus den Prüfungen zum Brandverhalten von Bauprodukten*. Österreichisches Normungsinstitut.
- ÖNORM EN 13501-2, 2012 02 15: *Klassifizierung von Bauprodukten und Bauarten zu ihrem Brandverhalten Teil 2: Klassifizierung mit den Ergebnissen aus den Feuerwiderstandsprüfungen, mit Ausnahme von Lüftungsanlagen*. Österreichisches Normungsinstitut.
- ÖNORM EN 13823, Jänner 2011: *Prüfungen zum Brandverhalten von Bauprodukten - Thermische Beanspruchung durch einen einzelnen brennenden Gegenstand für Bauprodukte mit Ausnahme von Bodenbelägen*. Österreichisches Normungsinstitut.
- ÖNORM EN 13829, 2001-05-01: *Wärmetechnisches Verhalten von Gebäuden - Bestimmung der Luftdurchlässigkeit von Gebäuden - Differenzdruckverfahren (ISO 9972:1996, modifiziert)*. Österreichisches Normungsinstitut.
- ÖNORM EN 15283-1, 2009 10 01: *Faserverstärkte Gipsplatten - Begriffe, Anforderungen und Prüfverfahren - Teil 1: Gipsplatten mit Vliesarmierung*. Österreichisches Normungsinstitut.

- ÖNORM EN ISO 717-1, 2006 01 12: *Akustik - Bewertung der Schalldämmung in Gebäuden und von Bauteilen - Teil 1: Luftschalldämmung*. Österreichisches Normungsinstitut.
- ÖNORM EN ISO 717-2, 2006 01 12: *Akustik - Bewertung der Schalldämmung in Gebäuden und von Bauteilen - Teil 2: Trittschalldämmung*. Österreichisches Normungsinstitut.
- ÖNORM EN ISO 11925-2, Februar 2011: *Prüfungen zum Brandverhalten - Entzündbarkeit von Produkten bei direkter Flammeneinwirkung - Teil 2: Einflammtest (ISO 11925-2:2010)*
Prüfungen zum Brandverhalten - Entzündbarkeit von Produkten bei direkter Flammeneinwirkung - Teil 2: Einflammtest (ISO 11925-2:2010) 11925-2:2011 02 15.
Österreichisches Normungsinstitut.
- ÖNORM H 6027, 2008-08-01: *Lüftungstechnische Anlagen - Feuerschutzabschlüsse in Lüftungsleitungen auf Basis intumeszierender Materialien mit mechanischem oder ohne mechanisches Verschlusselement - Verwendung und Einbau*. Österreichisches Normungsinstitut.
- ÖNORM H 6031, 2007-05-01: *Lüftungstechnische Anlagen - Einbau und Kontrollprüfung von Brandschutzklappen und Brandrauch-Steuerklappen*. Österreichisches Normungsinstitut.

Companies involved



storaenso



From wood to wonders.

